



PRODUCT MANUAL

# AGD306

Traffic Control Radar

# TABLE OF CONTENTS

**AGD306**

Traffic Control Radar

<b>INTRODUCTION</b>	<b>3</b>	<b>RADAR CHARACTERISTICS</b>	<b>24</b>
Product and technology	3	Radar Characteristics	24
Key features	3	Frequency Variants	25
Typical applications	4	306 Field Pattern	26
Product overview image	5		
Product variants	5	<b>TECHNICAL SPECIFICATIONS</b>	<b>27</b>
Product Overview	5	Product Specification	27
<b>INSTALLATION AND COMMISSIONING</b>	<b>6</b>	<b>CERTIFICATES</b>	<b>28</b>
Physical Installation	6		
Electrical Installation	7-8	<b>END OF LIFE DOCUMENT</b>	<b>29</b>
Connecting	9		
Set-up device using AGD Touch-setup	10-13	<b>IMPORTANT SAFETY INFORMATION</b>	<b>30</b>
		Safety precautions	30
<b>TECHNICAL RESOURCE</b>	<b>14-15</b>	Low power non-ionising radio transmission and safety	30
Transmit channel - typical scenario	14-15		
Typical detector performance 5-45m range	16	<b>DISCLAIMER</b>	<b>32</b>
Previous GUI version		Warranty	32
Set-up device using AGD Touch-setup	17-21	Contact Details	32
<b>TROUBLESHOOTING</b>	<b>22</b>		
Physical installation	22		
Connecting / Commissioning	23		



**AGDTOUCH**

WiFi 3 Click Setup

## INTRODUCTION

### VIEW AND TECHNOLOGY

The AGD306 is a smart FMCW radar which is designed to make vehicle movements at Traffic Control Installations more efficient. The design is also robust, cost-effective and highly configurable which also makes it suitable for multiple Intelligent Transport Systems (ITS) management applications.

The radar operation is 'trickle-down' technology from the proven and approved AGD range of speed enforcement products giving it significant pedigree at this level of product.

Configuration of the radar's settings is via the unique WiFi AGD Touch-Setup which allows users to set and monitor the radars performance wirelessly from a smart-phone or tablet without any proprietary software or app.



## KEY FEATURES

- Redesigned GUI now includes additional features, and easier configuration and validation of applied settings
- Easy setting configuration means one product for many applications
- Range configurable up to 120m
- Accurate detection zone for improved host system efficiency
- Performance is super tolerant to weather conditions and other sources of interference
- WiFi AGD Touch-setup - speeds installation & reduces risk
- Huge 50% reduction in power consumption on previous AGD206 product
- Architecture based on 32 bit ARM® Cortex® processing core

# INTRODUCTION

**AGD306**

Traffic Control Radar

## TYPICAL APPLICATIONS

### Intersection control

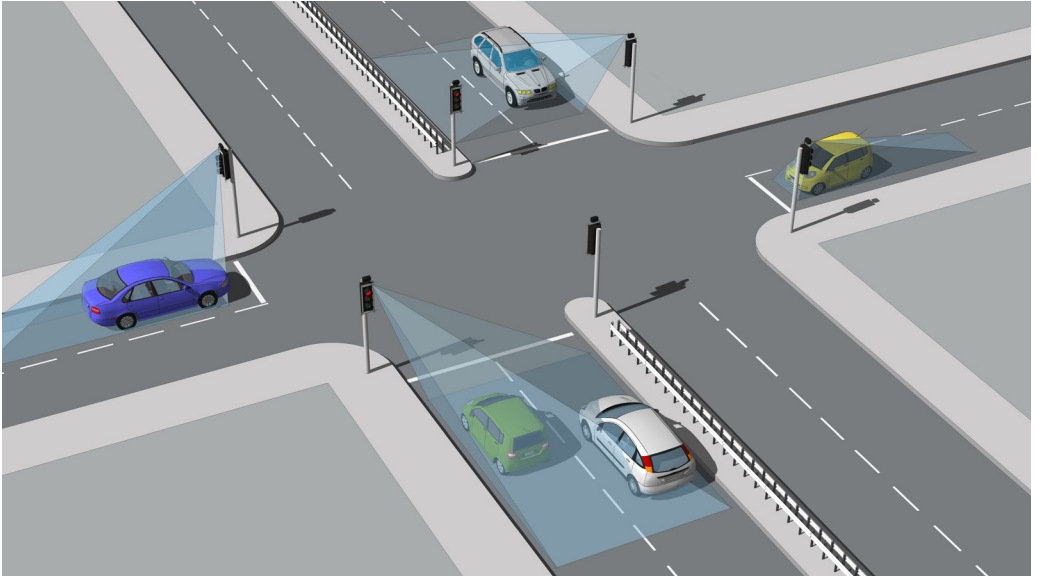

### Shuttle operation

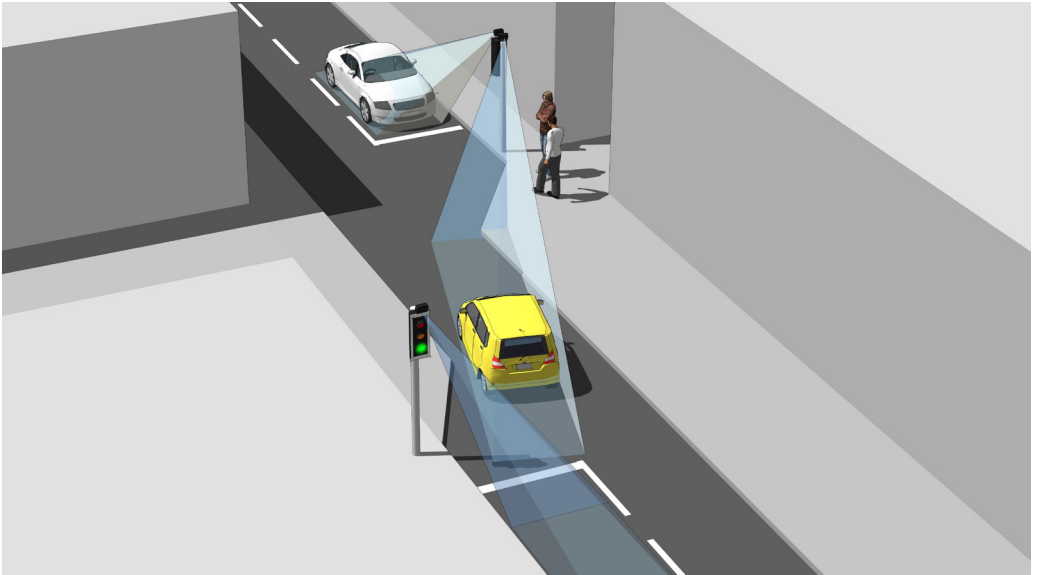

# INTRODUCTION

# AGD306

Traffic Control Radar

## PRODUCT OVERVIEW IMAGE

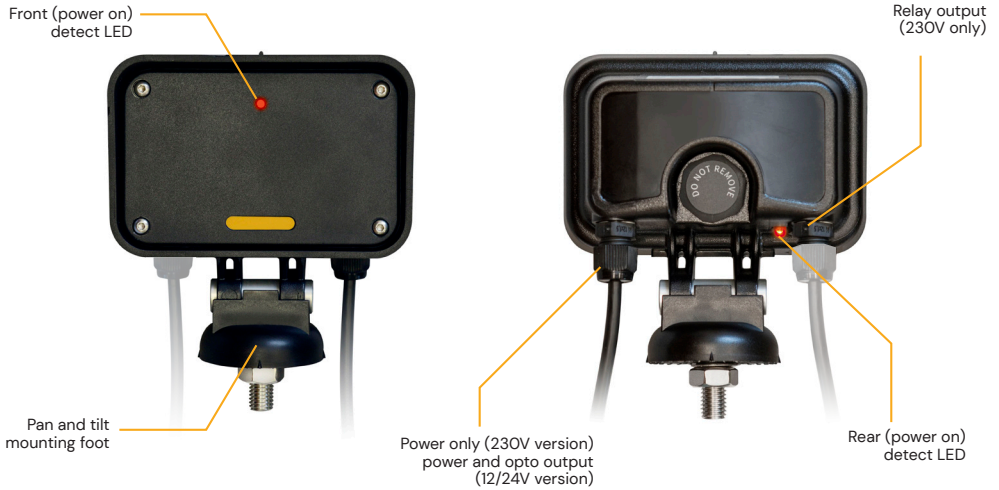

## PRODUCT VARIANTS

306-500-021	Perm signal radar / 12/24V ac/dc / 24GHz / Dual lane / Single opto output / 1m lead + 1.5m mating lead
306-501-021	Perm signal radar / 12/24V ac/dc / 24GHz / Dual lane / Single opto output / 1m lead + 4m mating lead
306-502-021	Perm signal radar / 12/24V ac/dc / 24GHz / Dual lane / Single opto output / 5m flying lead
306-300-021	Perm signal radar / 230Vac / 24GHz / Dual lane / Single relay output / 5m flying leads

# INTRODUCTION

**AGD306**

Traffic Control Radar

## PRODUCTION OVERVIEW

The AGD306 is an above ground dynamic radar detector. This compact unit, featuring a custom planar antenna has been specifically designed to detect a variety of targets at greater distances, whilst reducing power consumption by 50% over its predecessor. Improved tolerance to external sources of interference further improves host system efficiency.

The detector has a configurable, single zone of detection, covering a range of 5 to 120m along the carriageway.

An output is generated by the detector as the target travels above the low speed threshold within the specified area of detection.

The detector utilises AGD's WiFi Touch-setup. This 3 step process allows simple and easy configuration via a laptop, tablet or mobile device, without the need for any additional software or applications. Parameters that can be altered include detection direction (advancing, receding or bi-directional), low speed threshold (4 or 8 kph), maximum range (30-120m) and transmission channels (1-2), to help prevent interference between units.

New settings are implemented upon saving.



## PHYSICAL INSTALLATION STEP 1 - MOUNTING HEIGHT

### STEP 2 - DETECTOR ALIGNMENT

The AGD306 should be mounted using the supplied hardware. Direct the radar to point at the center of the furthest point of detection. For short range applications the detector should be angled down as shown in the diagram below. Lightly tighten the mounting nut to prevent any movement.

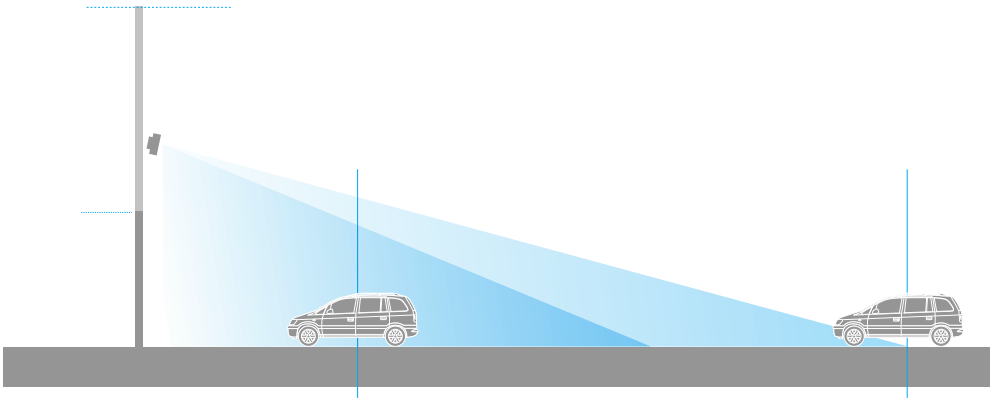

### STEP 3 - FINAL ADJUSTMENT & VERIFICATION

Confirm that the radar is correctly aligned by ensuring that targets are reliably detected within the specified detection zone. Adjust if necessary and retest. Once aligned correctly, ensure that the mounting nut is fully tightened and that the detector is secure.

## 12/24V AC/DC – MULTI-PIN CONNECTOR OR 5M FLYING LEAD

The AGD306 is powered by a 12/24V ac/dc supply. Power is supplied to the detector using the multi-pin mating connector.

The AGD306 is provided with a Buccaneer Series PX0728/S 9 Pin connector to enable direct connection to the traffic control system.

The pinouts of the connector and detector function are shown below:

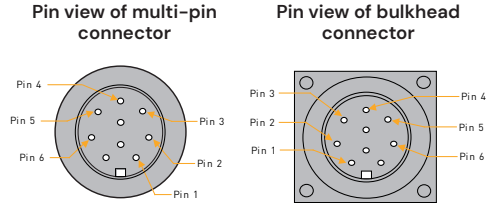

### SINGLE CABLE 12VDC/24V AC/DC SUPPLY WIRING (1M LEAD WITH MULTI-PIN CONNECTOR)

PIN NO.	WIRE COLOUR	FUNCTION	POWER OFF	POWER ON-NO DETECT	POWER ON-DETECT
1	Red	12/24Vdc (+) OV _____ or 24Vac	-	-	-
2	Black		-	-	-
3	Green	Not Connected	-	-	-
4	White	Common	-	-	-
5	Yellow	Opto	N/O	N/C	N/O
6	Blue	Opto	N/C	N/O	N/C
7, 8, 9	-	Not Connected			

### SINGLE CABLE 12VDC/24V AC/DC SUPPLY WIRING (5M FLYING LEAD)

WIRE COLOUR	FUNCTION	POWER OFF	POWER ON-NO DETECT	POWER ON-DETECT
Red	+24/42V ac/dc OV _____ or 24Vac	-	-	-
Black		-	-	-
Green	Earth/Ground	-	-	-
White	Common	-	-	-
Yellow	Opto	N/O	N/C	N/O
Blue	Opto	N/C	N/O	N/C

#### Opto-coupler ratings

- Max current 100mA
- Max Voltage 100V
- Max on-state impedance 25 Ohms

#### The voltage tolerances of supply are as follows:

- 210-30Vdc
- 24Vac ± 20% ac



## ELECTRICAL INSTALLATION

### 230VAC – 5M FLYING LEADS

The AGD306 is powered by 230Vac and it is essential supply. Consideration must be given to the multiple grounding of supplies and to its effect on the whole system. The detector is supplied with two 5m flying leads. One is the power supply for the detector and the other is the signal output and the correct cables should be identified before connection.

### CONNECTIONS FOR 230Vac VERSION

TWIN CABLE 230VAC SUPPLY WIRING (5M FLYING LEADS)					
CABLE	WIRE COLOUR	FUNCTION	POWER OFF	POWER ON-NO DETECT	POWER ON-DETECT
Power	Brown	230Vac Live	-	-	-
	Blue	230Vac Neutral	-	-	-
Signal	Red	Relay Common	-	-	-
	Blue	Relay Contact	N/C	N/O	N/C
	Green	Relay Contact	N/O	N/C	N/O

The switched outputs on the 230V variants are relays. It should be noted that the relays are rated at Max 230Vac and 500mA but also must have a minimum whetting load of 12Vdc 100mA. In addition the relay outputs are protected by protection device which limits current to 500mA and has a serial impedance of approximately 15 Ohms.



### APPLYING POWER

- Make sure the power supply is the correct voltage, which can be found on the label on the unit.
- Connect the unit to the supply.
- Once powered, the front and rear LEDs should flash five times whilst the radar performs its self check routines.

Upon power up, owing to the nature of the equipment's power supply, an initial current of up to 200mA can be drawn and the supply should be fused as follows:

- 230V MODELS:** This product must be protected by a 3A circuit breaker.  
**12/24V MODELS:** This product must be protected by a 1A circuit breaker or in-line fuse.

### TYPICAL POWER CONSUMPTION

- 12Vdc - 47mA (195mA peak)
- 24Vdc - 25mA (85mA peak)
- 24Vac - 49mA (95mA peak)
- 1230Vac - 9.6mA (20mA peak)

The installation of this equipment MUST conform to the latest edition of the IEE Wiring Regulations (BS7671).

## CONNECTING

AGD306 is configured using AGD WiFi Touch-setup. This is a simple, 3 step process, allowing the end user to connect and configure the unit via browser on their laptop, tablet or mobile device.

This step-through process describes the actions required to connect to the radar.

## CONNECTING WIFI

Upon powering up, wait for the LED on the rear of the unit to flash 5 times, this signifies that the firmware has correctly started. Search for the unit and identify the unit by its **serial number**:

**306:XXXXXX-XXXX** (the 'X' denotes the S/N)

Click 'connect' and input the **default password**:

**AGD306:XXXXXX-XXXX** (the 'X' denotes the S/N)

\*please note that this is case sensitive and contains special characters\*

The LED on the rear of the radar should now be illuminated blue to show that WiFi is successfully connected.

Your device should also show as connected on it's WiFi network tab.

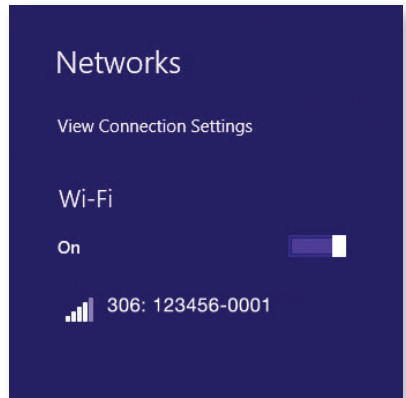

## CONNECTING DEVICE

Complete Wifi connection step as above.

Launch a browser on your smartphone, tablet or laptop (Modern versions of: Internet Explorer, Google Chrome and Safari are all supported - 2018 onwards).

In the address bar of your browser, enter the 'IP Address': **http://192.168.4.1**

You will be presented with your initial AGD Touch-setup page.

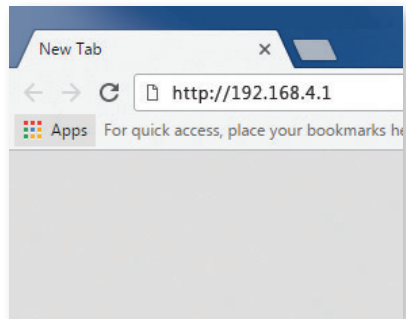

## SET-UP DEVICE USING AGD TOUCH-SETUP

Homepage

The screenshot shows the AGD306 radar homepage. At the top left is a 'Menu' button (three horizontal lines) and a 'Clear Button (resets target tracking info)'. The top right displays 'MI-208-5 (BANK1) REL-4' and '22ND SEPTEMBER 2021'. The main area is divided into three sections:

- Range Display:** A radar scan area with concentric dashed lines representing range in metres (10 to 120). A vertical double-headed arrow on the left indicates the 'Maximum Range' is set to 120m. A vertical orange box highlights the 'Live Tracking' area.
- Settings Panel:** A list of configuration options with dropdown menus:
  - Transmit Channel: 1
  - Front LED: ON
  - Rear LED: ON
  - Low Speed Threshold: 8
  - Hold Time: 800
  - Direction: ADVANCE
  - Fault Monitor Timeout: 0 (0 - 72hrs)
  - Detection Tracks: ON
- Opto Output Indicator:** A horizontal bar with two indicator lights. The left light is labeled 'Opto Output Indicator' and the right light is labeled 'Mute/ Unmute'. A small square icon with a red arrow is also present.

Homepage displays real time target tracking information. Valid target tracks appear as red dots along the centre line. This page can be used in conjunction with LED's on radar unit to confirm reliable target detections within the required detection zone. Target tracks can be reset using the **Clear** button.

**Menu** button (top left) gives access to radar settings.

**Maximum Range** – This sets the maximum distance at which AGD306 reports valid targets. Range is user selectable 20m–50m in 5m increments, 50m–120m in 10m increments.

**Opto-Output Indicator** – Provides a visual reference for output activation. Combined with **Mute/ Unmute** for output sounder, these can be used to quickly and accurately validate applied settings.

## Homepage (CONT.)

**Transmit Channel** – The AGD306 has 2 channels available (3–4 currently reserved for FCC compliant units). The default channel alternates based on the serial number of the unit. Odd numbered units are defaulted to channel 1 and even numbered units defaulted to channel 2. Under certain circumstances (such as two units facing each other in a shuttle working scenario), one unit may require changing to prevent interference between units.

**\*Check technical resource section for co-locating other AGD radars.**

Settings	
Transmit Channel	<input type="text" value="1"/>
Front LED	<input type="text" value="ON"/>
Rear LED	<input type="text" value="ON"/>
Low Speed Threshold	<input type="text" value="8"/>
Hold Time	<input type="text" value="800"/>
Direction	<input type="text" value="ADVANCE"/>
Fault Monitor Timeout	<input type="text" value="0"/> (0 - 72hrs)
Detection Tracks	<input type="text" value="ON"/>

**Front and Rear LED** – Independently control the front and rear LED's. Choose from ON, OFF, or TIMEOUT (LED turns off after 10 minutes).

**\*Note – LED's only operate when AGD306 detects a valid target\***

**Low Speed Threshold** – This is the speed at which valid targets are reported (default 8kph, 4kph option available). Any target travelling below the chosen threshold is ignored.

**Hold Time** – The amount of time the radar maintains it's detect state, after a valid target has exited the detection zone. Default = 800ms, with 500ms or 2000ms options available.

**Direction** – Select the direction of targets the require detection. Choose from ADVANCE, RECEDE or BI-DIRECTIONAL.

**Fault Monitor Timeout** – When no valid targets are detected within a set period, the radar will assume a fault condition and default to a permanent detect state. At default (0 hours) fault monitor timeout is disabled.

**Detection Tracks** – Automatically clears detection tracks from the live tracking area. Choose from 5, 10 or 20 seconds according to preference or target flow.

## SET-UP DEVICE USING AGD TOUCH-SETUP

### Product Information and WiFi

The screenshot shows the AGD306 touch-setup interface. On the left is a dark sidebar menu with options: 'Detector Config', 'Product information and Wifi', and 'Terminal'. The 'Product information and Wifi' option is highlighted. The main content area is divided into three sections: 'VERSION INFORMATION', 'WIFI SETTINGS', and 'FIRMWARE UPDATE'. The 'VERSION INFORMATION' section displays 'AGD SYSTEMS LTD AGD306', 'Version MI-216-1', and '17th February 2021'. The 'WIFI SETTINGS' section includes fields for 'SSID' (306:119288-0029-TBD), 'Password' (AGD306:119288-0029), 'Wifi Channel' (Auto), and 'Deep Sleep' (Disabled). The 'FIRMWARE UPDATE' section has two sections: 'RADAR' and 'WIFI', each with a 'Choose File' button, 'No file chosen' text, and a percentage indicator (0%), and an 'Upload' button.

Click on the menu

Select Product Information and WiFi

AGD 306  
TRAFFIC CONTROL RADAR

MI-208-5 (BANK1) REL-4  
22ND SEPTEMBER 2021

Detector Config

Product information and Wifi

Terminal

**VERSION INFORMATION**

AGD SYSTEMS LTD AGD306  
Version MI-216-1  
17th February 2021

**WIFI SETTINGS**

SSID (Up to 31 Upper-case characters, first 15 characters are reserved)  
306:119288-0029-TBD

Password (8 to 63 Upper-case characters)  
AGD306:119288-0029

Wifi Channel

Deep Sleep

**FIRMWARE UPDATE**

**RADAR**

No file chosen

0%

**WIFI**

No file chosen

0%

**Firmware Update** – The user can upload the latest radar/WiFi firmware here by uploading a zip file supplied by AGD. Please contact AGD Technical Support for further information.

**Version Information** – Contains important information on radar firmware version. For information only.

## SET-UP DEVICE USING AGD TOUCH-SETUP

### Product Information and WiFi

#### WiFi Settings

**SSID** – Allows the user to amend AGD306 WiFi SSID. Format of SSID as standard is as follows: **306:XXXXXX-XXXX** (where 'X' denotes the serial number of the unit). Characters after this can be amended to allow for easy unit identification whilst on-site.

**Password** – allows user to change WiFi password from default. AGD DO NOT recommend changing the password from default as unit will need to be returned to base in the event of a lost password. Default password is as follows: **AGD306:XXXXXX-XXXX** (where 'X' denotes the serial number of the unit). \*Please note – password is case sensitive and includes special characters\*

**WiFi Channel** – Choose from 1, 6 or 11. Default **Auto**. Under certain circumstances, it may be necessary to force the WiFi to operate on a specific channel (to avoid interference from external sources). If you are experiencing an issue communicating with a unit in an on-street environment, please contact AGD Technical Support for further assistance.

**WiFi Deep Sleep** – This setting (when enabled) will disable the WiFi connection after the selected period of initial power up. If a WiFi connection is required after this period, then the unit will need to be power cycled prior to any connection attempts. Default setting is 'enabled' with a time period of 24 hours.

#### WIFI SETTINGS

SSID (Up to 31 Upper-case characters, first 15 characters are reserved)

Password (8 to 63 Upper-case characters)

Wifi Channel

Deep Sleep

## TRANSMIT CHANNELS - TYPICAL SCENARIOS

### Co-Location of AGD Detectors

Installing two or more AGD detectors e.g 306, 326 or 316, 326 on the same traffic signal pole can result in crosstalk and a degradation in performance if they are on the same frequency.

Please be mindful of additional AGD products located on the same pole or in the vicinity of any new installation.

#### Example 1: Various On-crossing and MVD/Stop Line Detection

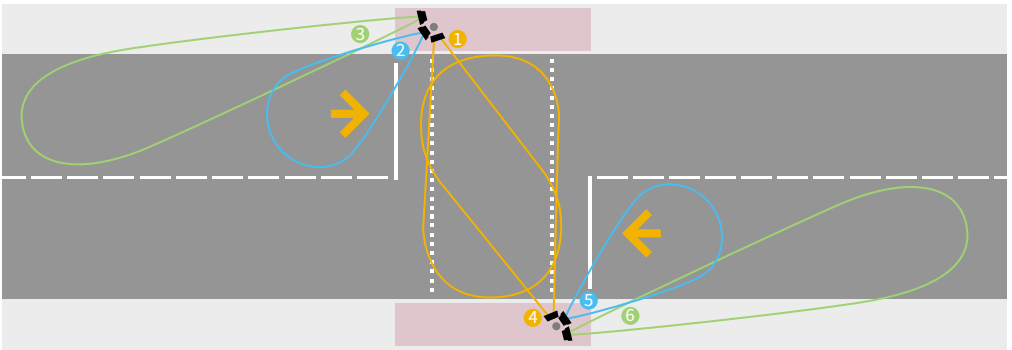

#### Suggested Settings

No.	AGD Product	Channel
1	AGD326	1
2	AGD316	n/a
3	AGD306	2
	AGD318	1*
4	AGD326	2
5	AGD316	n/a
6	AGD306	2
	AGD318	1/2*

\* Please contact AGD technical support if attempting to co-locate AGD306 and AGD318.

technical.support@agd-systems.com

Tel: +44 (0) 1452 557404

## TRANSMIT CHANNELS - TYPICAL SCENARIOS

Table 1: AGD 24GHz Radar Channels

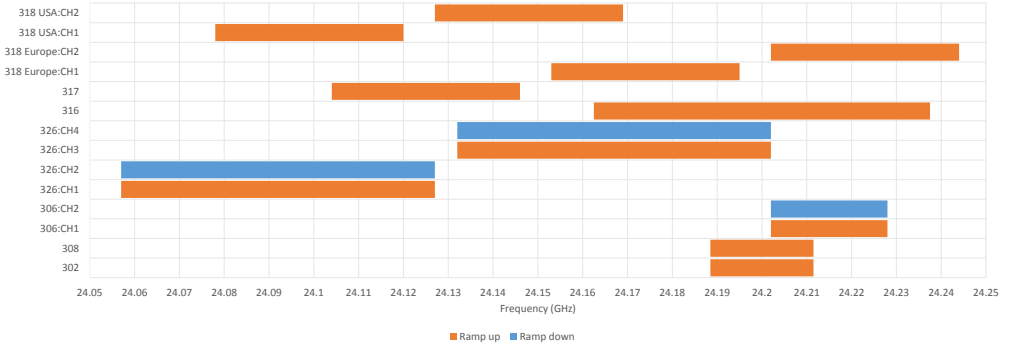



TYPICAL DETECTOR PERFORMANCE 5–45M RANGE

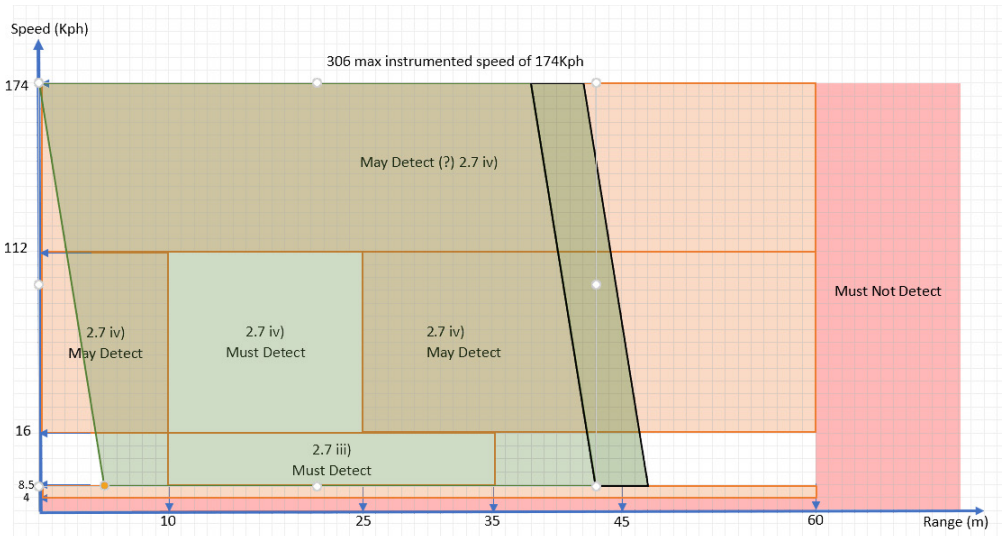

306 typical detection performance for 5–45m range setting showing detection map in green (Not bikes and mopeds)

(Turn on delay and range error bordered in black)

Please contact AGD Technical Support for further information

## SET-UP DEVICE USING AGD TOUCH-SETUP

### Homepage

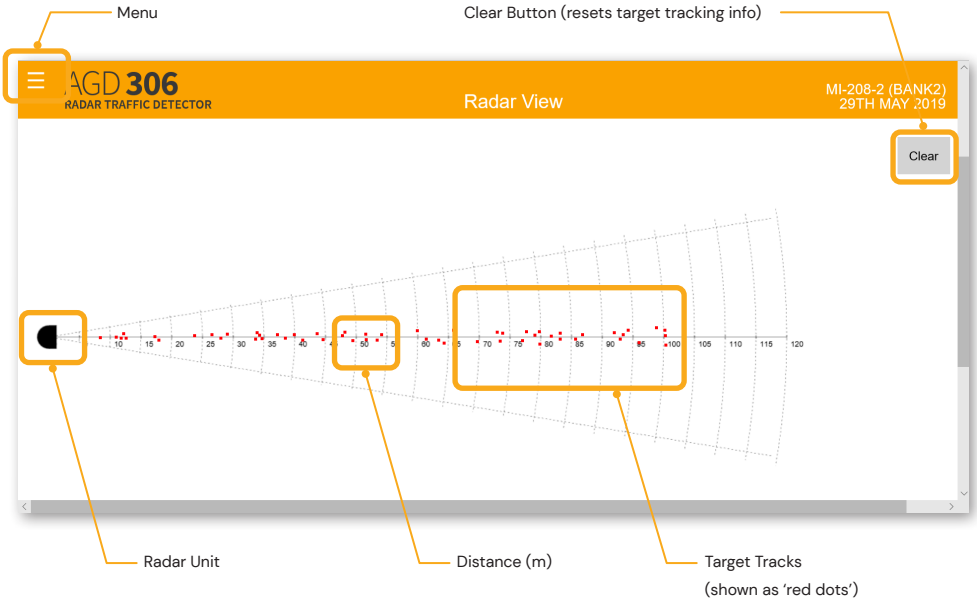

Homepage displays real time target tracking information. Valid target tracks appear as red dots along the centre line. This page can be used in conjunction with LED's on radar unit to confirm reliable target detections within the required detection zone.

**Menu** button (top left) gives access to radar settings.

## SET-UP DEVICE USING AGD TOUCH-SETUP

### Settings

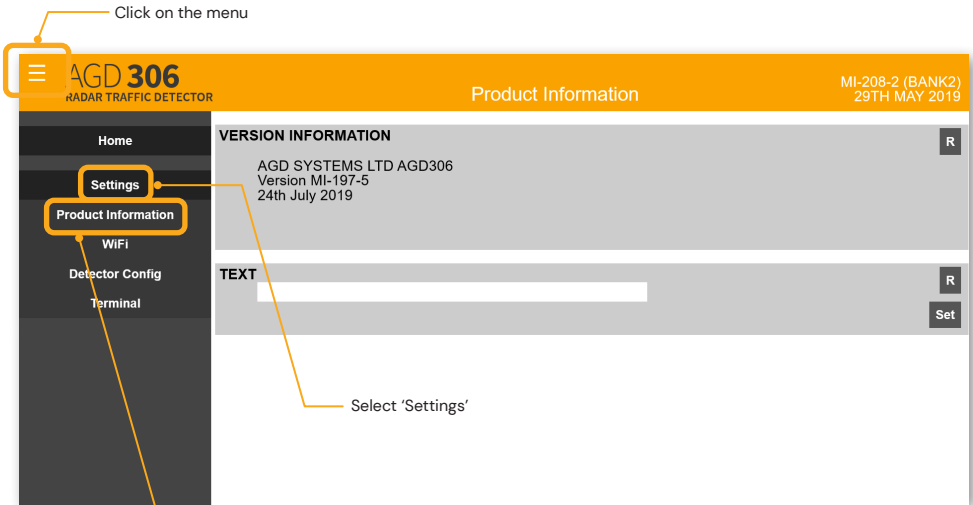

Product Information – This provides the user with AGD306 version information and the ability to populate a free text box. This can be used for identification numbers, or any other information that may be required (max 62 characters).

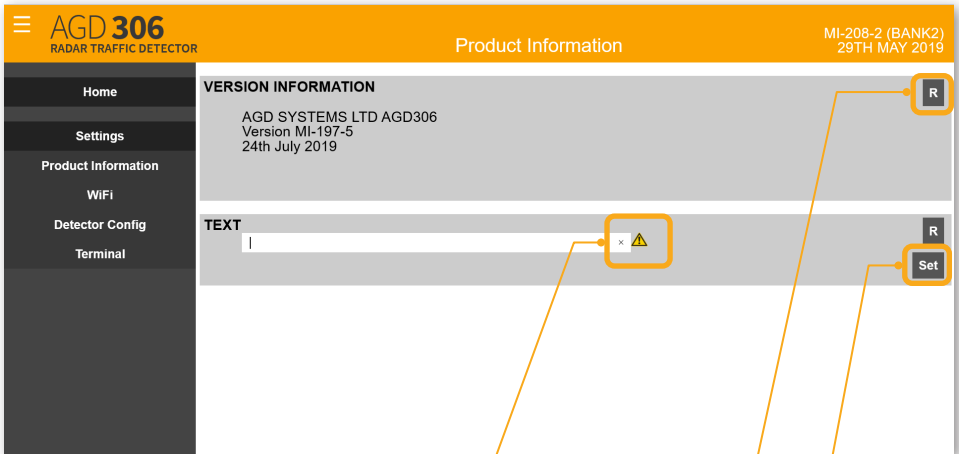

If changes are made to ANY settings, this is represented by an exclamation mark at the end of the box.

Clicking 'R' queries current saved value.

Changes must be saved using the 'SET' button before progressing, otherwise any changes made will be lost.

SET-UP DEVICE USING AGD TOUCH-SETUP

Detector Configuration

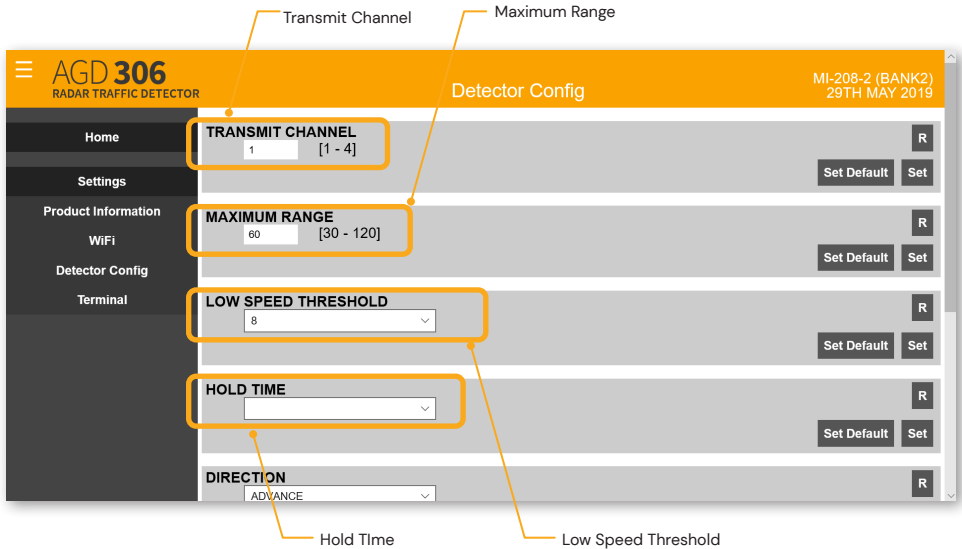

**Transmit Channel** – The AGD306 has 2 channels available (3-4 currently reserved for FCC compliant units). The default channel alternates based on the serial number of the unit. Odd numbered units are defaulted to channel 1 and even numbered units defaulted to channel 2. Under certain circumstances (such as two units facing each other in a shuttle working scenario), one unit may require changing to prevent interference between units.

*\*Check technical resource section for co-locating other AGD radars.*

**Maximum Range** – This sets the maximum distance at which AGD306 reports valid targets. Range is user selectable 30m-120m (default 60m) in 10m increments.

**Low Speed Threshold** – This is the speed at which valid targets are reported (default 8kph, 4kph option available). Any target travelling below the chosen threshold is ignored.

**Hold Time** – The amount of time the radar maintains it's detect state, after a valid target has exited the detection zone. Default = 800ms, with 500ms or 2000ms options available.

SET-UP DEVICE USING AGD TOUCH-SETUP

Detector Configuration (contd)

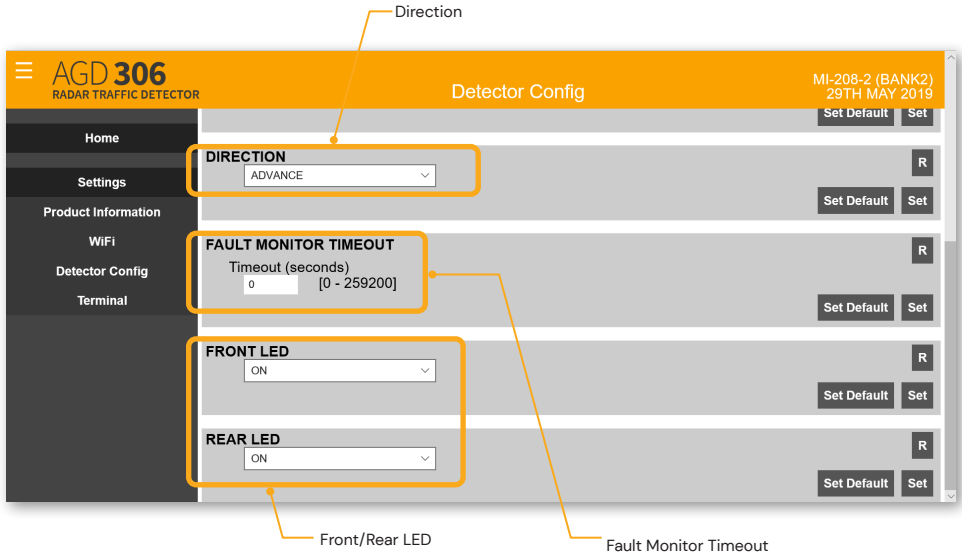

**Direction** – Select the direction of traffic that requires detection. Select from advance, recede or bi-directional.

**Fault Monitor Timeout** – When no valid targets are detected within a set period, the radar will assume a fault condition and default to a permanent detect state. At default (0 seconds) fault monitor timeout is disabled.

**Front/Rear LED** – Individual control over front and rear LED’s. Option to switch on, off or timeout. If timeout is selected, LED’s will automatically switch off after 10 mins of initial power up.

### **What height should the AGD306 be mounted at?**

The AGD306 has a recommended mounting height of between 2-5m (from ground level).

### **Is there a recommended angle that the AGD306 should be set to?**

The AGD306 should be carefully aligned for optimum performance and set-up is best achieved under light traffic conditions.

The detector should be panned to point at the centre of the carriageway at the furthest point at which detection is required. For a dual carriageway approach the detector should be aligned with the road markings separating the two lanes. The LED on the detector should be observed during alignment to ensure the onset of detection occurs at the correct point.

### **Will AGD306 operate correctly with obstructions?**

All radar units are designed to operate with a clear 'line of sight'. Any obstructions may result in loss of performance or false detections. The BR-129 height extension bracket should be implemented where required to avoid potential obstructions from traffic light heads.

### CONNECTING AND COMMISSIONING

#### How many lanes of traffic can the AGD306 detect vehicles in?

The AGD306 can detect targets in up to 2 lanes of bi-directional traffic. It is not able to discriminate which lane a target is traveling in.

#### What is the maximum range of the AGD306?

AGD306 is configurable to allow detection up to 120m. These functions are available via the AGD Touch-setup 'Settings' page.

#### Can the AGD306 detect vehicles in both directions?

Yes, the AGD306 can be configured to detect either bi-directional, advancing or receding only traffic.

For example; this function is regularly deployed on traffic signals where the control of two-way traffic across a single lane, such as 'shuttle working bridges' is required.

#### What speeds can the AGD306 detect vehicles at?

The AGD306 has a selectable low speed threshold of either 8 kph (default) or 4 kph. A detection output will only be activated if the target is traveling above the selected limit.

#### If two AGD306's are facing each other (i.e. shuttle working on a bridge) can their radar signals interfere with the opposing unit?

Yes. Any radar unit has the potential to interfere with another unit operating within the same band (frequency). To overcome this, the AGD306 has the option of 2 user selectable channels (via AGD Touch-setup) to minimize any potential interference between units.

#### Can the AGD306 detect bicycles?

Yes, the AGD306 will detect bicycles travelling above the low speed threshold. However, as a bicycle is a smaller target than a motor vehicle, detection range may be reduced.

#### Why can't a simple hand-wave test be carried out on the AGD306, the same as could be done on previous models?

The 306 employs a planar antenna and detection and tracking algorithm software that is optimised only for the profile of moving vehicles. Waving a hand in front of the 306 does not produce a suitable profile which the unit would recognise as a valid target and will be ignored. This is very good for filtering out unwanted targets such as moving tree branches close to the detector.

# RADAR CHARACTERISTICS

**AGD306**

Traffic Control Radar

## PHYSICAL INSTALLATION

The radar has been designed to have a specific set of functional characteristics which make it suitable for traffic control applications.

### Radar Antenna

The antenna is a planar patch array with the following performance:

PARAMETER	SPECIFIED	NOTES
Horizontal Beam-width	33°	-3dB (HPBW)
Vertical Beam-width	33°	-3dB (HPBW)
Side-lobe suppression	>20dB	
E-Field	Vertical	Plane polarised

### Operating Frequency Band and Power

The AGD306 radar utilizes a temperature compensated transceiver design. The hardware has been designed to operate in the 'K band' range of frequencies at 24.215GHz.

PARAMETER	SPECIFIED	NOTES
Centre Frequency	24.215GHz*	
Power	<100mW eirp	
Field Strength	Typically 750m V/m	At 3m
ITU Code	26M0FXN	

\*Proposed channels for FCC variant, 24.125GHz

### WiFi Frequency and Power

- Frequency range (MHz): 2412–2472
- Highest EIRP power in the range (dBm): 18.52



## Frequency Modulation

The radar is an FMCW radar where the Frequency Modulation (FM) characteristics give the radar a transmit bandwidth of 26MHz. The FM is such that it is symmetric about the centre frequency of the band it is operating in.

The change in transmit 'bandwidth' with temperature is measured to be typically 30KHz/°C. The stability of the bandwidth over time is anticipated being better than 3% in the first year and lower for each subsequent year.

## Frequency Variants

Several versions of this product are available at frequency options which are for use in different geographic regions related to the radio requirements of that specific jurisdiction as follows;

Frequency Variant	EU Country of Use	Other Countries	Notes
24GHz	No current restrictions within the EU	AU, NZ, TR	

For other countries please contact AGD.

These products may **not** be used in the following geographic regions;

Restriction Type	EU Country	Other Countries
Relevant 24GHz Band not allocated		USA, CAN
Licence Required for Use		
Frequency Allocated but EIRP too high		

It is important to note that this table is updated from time to time. Please contact AGD for latest information if your intended country of use is not currently represented.

(Note: Countries are listed by their ISO 3166 2 letter code)

AGD306 FIELD PATTERN

TX- ANTENNA PATTERN

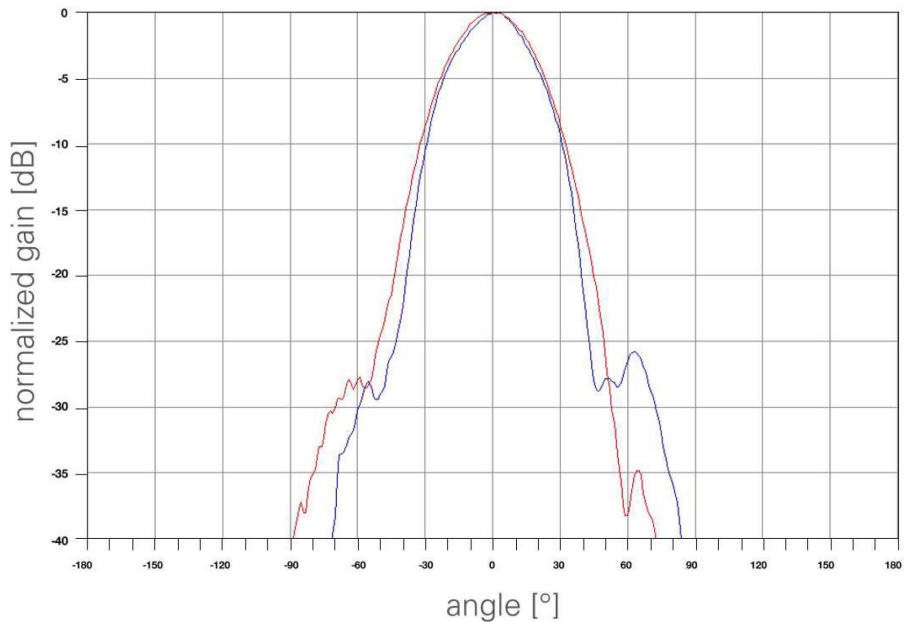

## PRODUCT DIMENSIONS

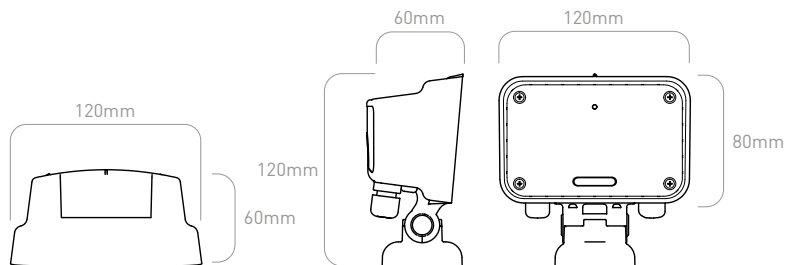

### SPECIFICATIONS

<b>Description</b>	Traffic Control Radar
<b>Technology</b>	24GHz FMCW Radar
<b>Detection Range</b>	5 to 120m (user selectable)
<b>Mounting Height</b>	2–5m Nominal
<b>Power Supply</b>	12/24V ac/dc or 230Vac
<b>Power</b>	0.84W @ 12Vdc @ 70mA / 0.84W @ 24Vdc @ 35mA 1.34W @ 24Vac @ 56mA / 2.21W @ 230Vac @ 9.6mA
<b>Detect Output</b>	Single Opto
<b>LED Indication</b>	LED for detect and WiFi connection
<b>Detection Threshold</b>	4 kph – 8 kph (user selectable)
<b>Housing Material</b>	Black Polycarbonate
<b>Sealing</b>	IP65
<b>Operating Temp</b>	-20°C to +60°C
<b>Configuration</b>	WiFi AGD Touch-setup
<b>Dimensions</b>	W 120mm x D 60mm x H 120mm
<b>Weight</b>	350g Typical
<b>Complies with</b>	EN 301 489, EN 50293, EN 300 440, EN 62368-1 FCC CFR47 Part 15.245, RSS-210, AS/NZS 4268
<b>Specification</b>	TOPAS 2505A

### OPTIONS

1. Power supply options of 12–24V ac/dc and 230Vac available.
2. Frequency option preset to suit local requirements. See Radar Characteristics section for typical frequency ranges.

### ACCESSORIES

- CA-083 Mating Bulgin connector complete with 1.5m cable
- BR-129 Height extension bracket

Owing to the Company's policy of continuous improvement, AGD Systems Limited reserves the right to change their specification or design without notice.



Restriction on Hazardous Substances

## EU Declaration of Conformity

Certificate No: CE-077 Issue: 1

We AGD SYSTEMS LTD  
White Lion House  
Gloucester Road  
Staverton  
Cheltenham  
Gloucestershire  
GL51 0TF  
UNITED KINGDOM

# AGD<sup>®</sup>

PRODUCT SOLUTIONS FOR  
INTELLIGENT TRAFFIC SYSTEMS

**AGD Systems**  
White Lion House, Gloucester Road,  
Cheltenham, GL51 0TF, UK  
**Tel:** +44 (0) 1452 854212  
**eMail:** info@agd-systems.com  
**Web:** agd-systems.com

as manufacturer hereby declare that the following product(s)

Equipment Model Type(s): AGD306-3xx-xxx  
AGD306-5xx-xxx-

Equipment Description: Radar Traffic Detector

conform with the provisions of the following EC Directive(s), including all amendments, and with national legislation implementing this / these directive(s):

2014/53/EU relating to Radio Equipment.

2011/65/EU RoHS Directive

and that the following harmonised standards and Technical Specifications have been applied:

EMC (Art 3.1(b)):	EN50293:2012 EN301 489-51 V2.1.0 EN301 489-1 V2.1.1
Health & Safety (Art 3.1(a)):	EN 62368-1:2014 EN 50556:2011 EN 62479:2010
Spectrum (Art 3.2):	EN300 440 V2.2.0 EN 300 328 V2.1.1
ROHS	EN 50581:2012

Notified Body Element Materials Technology 0891

EU type certificate EMT19RED1135

Signed



Dated:

21/8/19.

For and on behalf of AGD Systems Ltd  
P M Hutchinson  
Managing Director

*safer, greener, more efficient*

Registered in England and Wales No. 2666988

## AGD306 TRAFFIC CONTROL RADAR

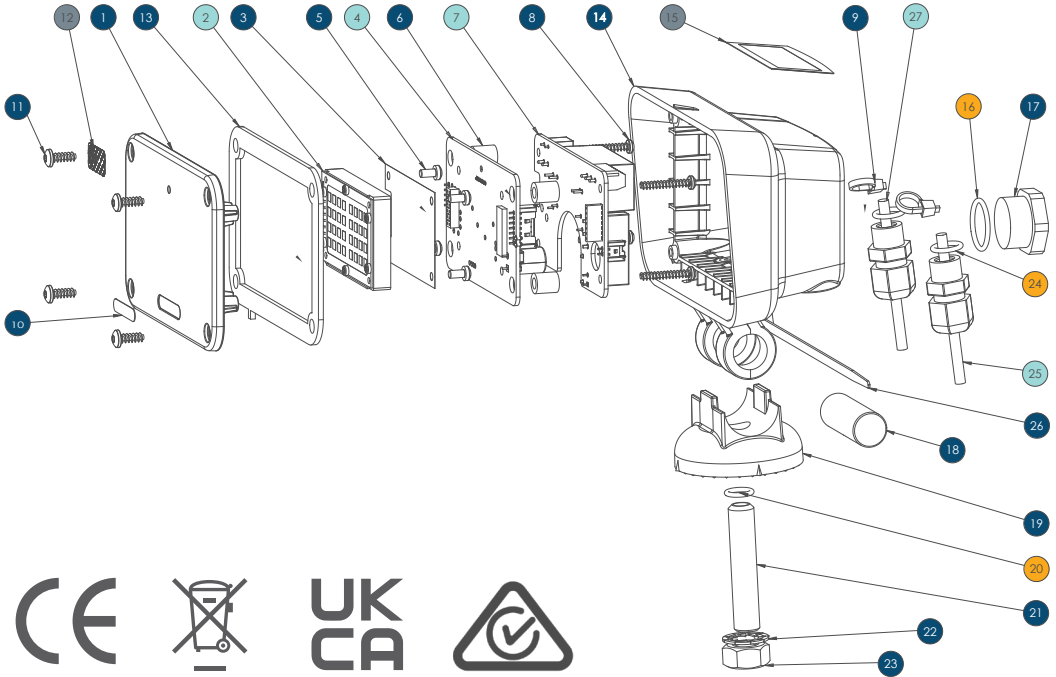

Item	Qty	Material	Item	Qty	Material
1	1	Polycarbonate	15	1	Polyester
2	1	Printed Circuit Board	16	1	Nitrile Rubber
3	1	Polyester	17	2	Nylon
4	1	Printed Circuit Board	18	1	Aluminium
5	4	Stainless Steel	19	1	Polycarbonate
6	4	Nylon	20	1	Nitrile
7	1	Printed Circuit Board	21	1	Stainless Steel
8	4	A2 Stainless Steel	22	1	Stainless Steel
9	2	Nylon	23	1	Stainless Steel
10	1	Polyester	24	2	EDPM
11	4	A2 Stainless Steel	25	1	Metals, PVC, Nylon
12	1	Polyester	26	1	Nylon 66
13	1	Neoprene	27	1	Metals, PVC, Nylon
14	1	Polycarbonate			

- Reuse / Recycle
- Separate & Recycle
- Downcycle
- Hazardous Recovery
- Non-Recyclable

This document serves as a guideline only for EOL procedures and further guidance may need to be sought from the appropriate authority or agency.

## SAFETY PRECAUTIONS

All work must be performed in accordance with company working practices, in-line with adequate risk assessments. Only skilled and instructed persons should carry out work with the product. Experience and safety procedures in the following areas may be relevant:

- **Working with mains power**
- **Working with modern electronic/electrical equipment**
- **Working at height**
- **Working at the roadside or highways**

1. This product is compliant to the Restriction of Hazardous Substances (RoHS – European Union directive 2011/65/EU).
2. Should the product feature user-accessible switches, an access port will be provided. Only the specified access port should be used to access switches. Only non-conductive tools are to be used when operating switches.
3. The product must be correctly connected to the specified power supply. All connections must be made whilst the power supply is off or suitably isolated. Safety must always take precedence and power must only be applied when deemed safe to do so.
4. No user-maintainable parts are contained within the product. Removing or opening the outer casing is deemed dangerous and will void all warranties.
5. Under no circumstances should a product suspected of damage be powered on. Internal damage may be suggested by unusual behaviour, an unusual odour or damage to the outer casing. Please contact AGD for further advice.
6. This device complies with part 15 of the FCC Rules.
  - Operation is subject to the following two conditions:
    - (1) This device may not cause harmful interference, and
    - (2) This device must accept any interference received, including interference that may cause undesired operation.
  - This equipment complies with FCC radiation exposure limits set forth for an uncontrolled environment. End users must follow the specific operating instructions for satisfying RF exposure compliance such that the module should not be installed in equipment intended to be used within 20cm of the body.
  - The transmitter must not be co-located or operating in conjunction with any other antenna or transmitter.
  - Changes or modifications not expressly approved by AGD Systems Ltd could void the user's authority to operate the equipment.
7. This Product is Compliant with the European Radio Equipment Directive 2014/53/EU. There is no restrictions of use within any EU Member state for this product. This product is Receiver Category 2.
8. Indicates compliance with all applicable Australian ACMA technical standards and associated record-keeping (including testing) arrangements.

## Low Power Non-Ionising Radio Transmission and Safety

Concern has been expressed in some quarters that low power radio frequency transmission may constitute a health hazard. The transmission characteristics of low power radio devices is a highly regulated environment for the assurance of safe use.

There are strict limits on continuous emission power levels and these are reflected in the testing specifications that the products are approved to. These type approval limits are reflected in the product specifications required for a typical geographic area such as those for the EU (ETS300:440), for the USA (FCC part 15c) and for Australia/New Zealand (AS/NZS 4268). The limits adopted in these specifications are typically replicated in many other localized specifications.

The level of safe human exposure to radio transmission is given by the generally accepted guidelines issued by the International Commission on Non-Ionizing Radiation Protection (ICNIRP). This body has issued guidance for limiting exposure to time-varying electric, magnetic and electromagnetic fields (up to 300 GHz) which are quoted below.

	Radar and ICNIRP limit comparison			Typical Informative Limits for Radar Transmission Approval		
	Radar Transmitted Level (Note 4)	ICNIRP Limit (Table 6)	Exposure Margin	ETS300:440	FCC (part15c)	AS/NZS 4268
Power (mW EIRP)	<100mW (<20dBm)	N/A	N/A	100mW (20dBm)	1875mW (Note 1)	100mW (20dBm)
Max Power Density (mW/cm <sup>2</sup> )	3.18μW/cm <sup>2</sup> at 50cm (Note 3)	<50W/m <sup>2</sup> (5mW/cm <sup>2</sup> ) (Note 2)	0.064%	N/A	N/A	N/A
Field Strength (V/m) at 3m	<0.58V/m (5.8mV/cm) (Note 1)	<137V/m (1370mV/cm)	0.42%	0.58V/m (5.8mV/cm) (Note 1)	2500mV/m (25mV/cm)	0.58V/m (5.8mV/cm) (Note 1)

*Note 1 Values are calculated conversions for comparison purposes.*

*Note 2 Other equivalent limits include; Medical Research Council Limit of 10mW/cm<sup>2</sup>, IACP limit of 5mW/cm<sup>2</sup> (at 5cm) and UK CAST limit of 5mW/cm<sup>2</sup>. Power density at the radome typically 4μW/cm<sup>2</sup>.*

*Note 3 Calculation is made on the assumption antenna is a point source therefore the actual value is likely to be significantly less than that quoted. Note that a theoretical max level at a 5cm distance (which gives 0.318mW/cm<sup>2</sup>) is at a point in the field where the radar beam is not properly formed.*

*Note 4 Comparison for product model 306 operating in the band typically 24.050GHz to 24.250GHz.*

From the table it can be seen that it is extremely unlikely that a potentially hazardous situation could occur owing to the use of such low power devices.

It is considered to be good practice not to subject humans to radiation levels higher than is necessary. In a works environment where multiple equipment on soak test are to be encountered then it is considered good practice to contain the equipment in an appropriate enclosure lined with radar absorbing material.

## DISCLAIMER

---

While we (AGD Systems) endeavour to keep the information in this manual correct at the time of download or print, we make no representations or warranties of any kind, express or implied, about the completeness, accuracy, reliability, suitability or availability with respect to the information, products, services, or related graphics contained herein for any purpose.

Any reliance you place on such information is therefore strictly at your own risk. In no event will we be liable for any loss or damage including without limitation, indirect or consequential loss or damage, or any loss or damage whatsoever arising from loss of data or profits arising out of, or in connection with, the use of this manual.

### Warranty

All AGD products are covered by a 12 month return to factory warranty. Products falling outside this period may be returned to AGD Systems for: evaluation, repair, update or re-calibration, any of which may be chargeable.

Revision
Issue 3 April 2021



**AGD**<sup>®</sup> | SAFER  
GREENER  
MORE EFFICIENT

### **AGD Systems Limited**

White Lion House, Gloucester Road,  
Cheltenham, GL51 0TF, UK

**Tel:** +44 (0) 1452 854212

**Email:** [info@agd-systems.com](mailto:info@agd-systems.com)

**Web:** [agd-systems.com](http://agd-systems.com)