

# AGD343

## Highways Monitoring Radar

**The AGD343 Highways Monitoring Radar represents class leading traffic flow monitoring technology offering an unrivalled alternative to outdated high maintenance loop systems.**

With the option to be sited just 2m from the nearest running lane, with visibility across up to 10 lanes, the AGD343 solution provides real-time, multi-lane highways data and dramatically enhances highways safety, capability and efficiency.

The AGD343 deploys proven enforcement-grade radar and sophisticated measurement techniques to quantify speed, range and length of passing vehicles. Detailed traffic information such as, 'is traffic free-moving, slowing or starting-to-queue?' is available in all weather conditions to inform control rooms, allow instant decision making and paves the way for the roads of the future.

AGD radar is mounted on existing roadside poles or gantries, crucially at a 30° angle. The additional capability to operate at a > 2-metre offset, while maintaining a 6-metre plus mounting height, ensures reliable operation in managed motorway scenarios and ALR (All Lanes Running) schemes.

The AGD343 has been purpose-designed to enable system integrators, road authorities and traffic engineers worldwide to deliver safer, greener, and more efficient transport environments, meeting the needs of today and overcoming the challenges of tomorrow.

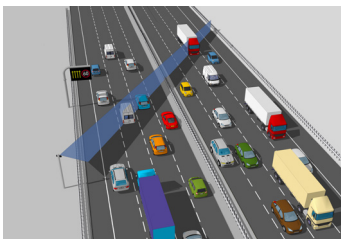

Multi-Lane Highways Monitoring Radar  
- Dedicated Infrastructure Mounted

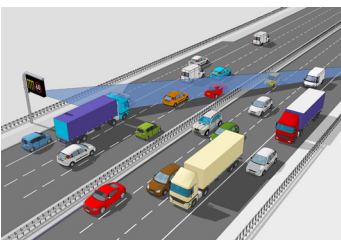

MS4 Mounted

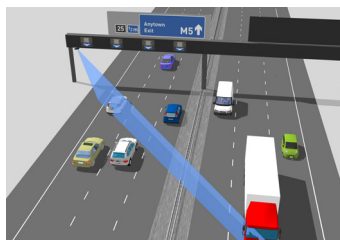

Gantry Mounted

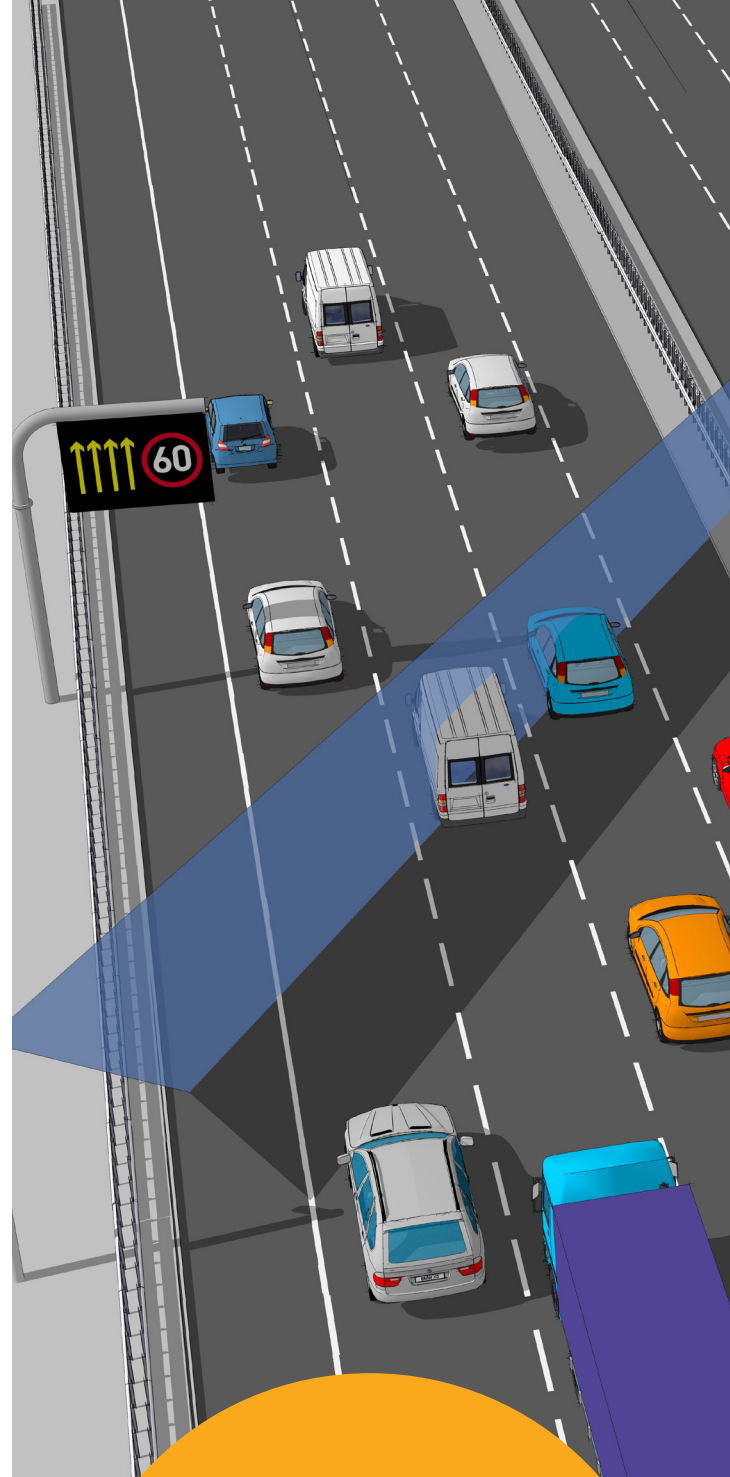

## KEY FEATURES

- Simple to install, setup and configure using AGD Align
- Enforcement grade radar identifies, tracks & measures speed, length, lane and direction of individual targets
- Ten lane highway capability at just a 2-metre offset
- Mounts on existing infrastructure

# AGD343

## Highways Monitoring Radar

### AGDALIGN

Touch Setup Tool

#### 3 STEP SETUP

Using intuitive hardware and Highways & Enforcement optimised AGD Align camera-based setup tool, the AGD343 Highways Monitoring Radar is simple to install, setup and configure.

The reliable deployment of the radar is split into three easy stages:

**1. Install** Mount the radar and align using camera-based technology

**2. Define** Allocate lane positions with data histogram analysis

**3. Verify** Ensure correct traffic data operation and connection to host system

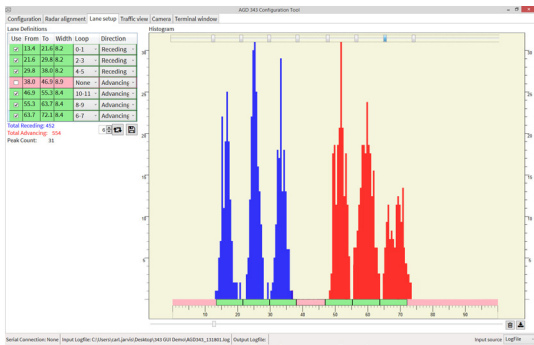

#### PRODUCT SPECIFICATION

Description	Highway Monitoring Radar
Technology	24GHz FMCW Radar
Mounting	Pole, portal gantry, MS3, MS4 or other structures
Mounting Height	6 metres nominal
Range	2-100 metres
Speed Range	5-250 kph
Housing Material	Black Polycarbonate / Aluminium
Sealing	IP66 & NEMA 250 4X
Operating Temp	-34°C to +74°C
Power	6 W @ 24Vdc
Power Supply	12 - 24V dc
Configuration	AGD Align Setup Tool
Dimensions	W 113.1mm x D 70mm x L 289.1mm
Radar Output	RS422
Weight	1400g

EMC: BS EN 50293:2012, EN 301 489  
Health & Safety: BS EN 62368, EN 60950-22,  
EN 50556, EN 62311  
Spectrum: EN 300 440  
RoHS: EN 50581  
Other: FCC CFR47 Part 15.245, NEMA TS 2 2016

#### Approvals

#### DIMENSIONS

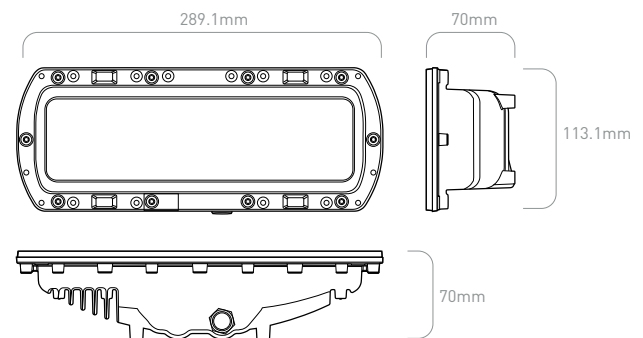

#### INTEGRATION

Ease of interface is designed into the AGD343 radar which provides detailed traffic data for direct integration with many international schemes – AGD ITS Integration Services can assist as required. For UK MIDAS implementations, an off-the-shelf AGD Janus8 ITS Interface Card provides a straight forward radar-to-out-station loop-replacement solution.



#### TESTED AND AGD CERTIFIED

All AGD products are Tested, Calibrated and AGD Certified so customers know that all devices will perform exactly as described.

# AGD343

## Highways Monitoring Radar

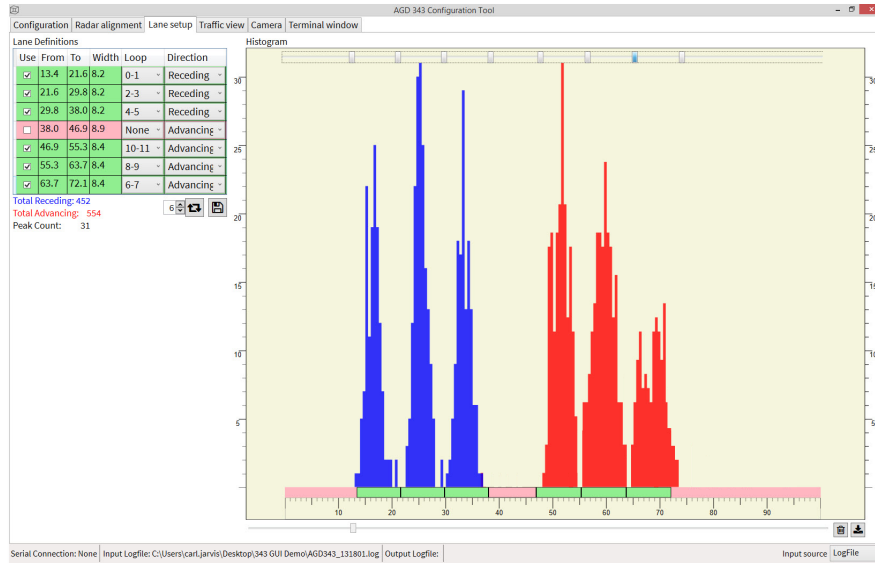

The AGD343 monitors traffic and allocates lane positions with a data histogram. Lanes are simply allocated a range and corresponding loop output (UK Specific Midas Variant).

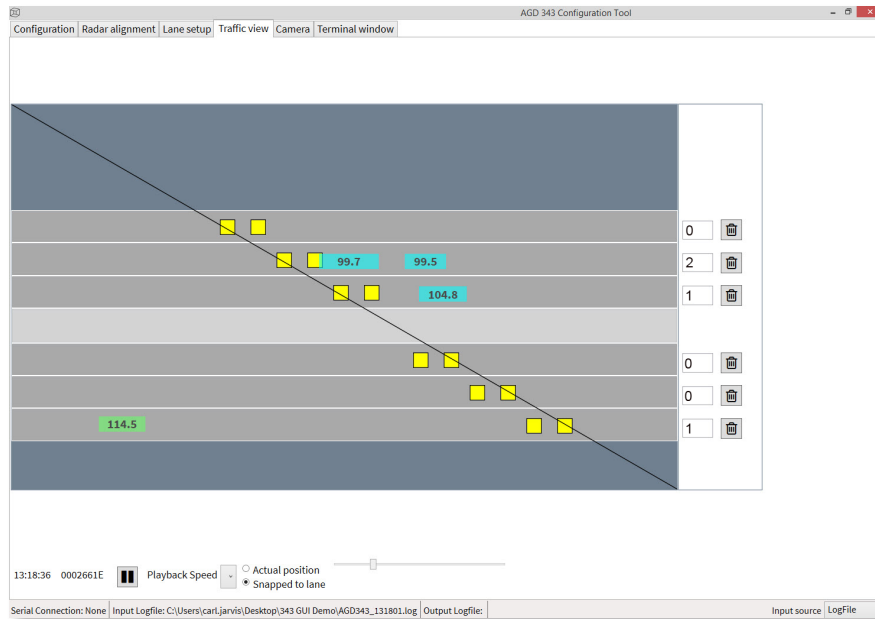

Traffic counts are verified with simple to use software tools, enabling accurate checks to be performed before connecting to host systems.

**AGD** SAFER  
GREENER  
MORE EFFICIENT

AGD Systems Limited  
White Lion House, Gloucester Road  
Cheltenham, GL51 0TF, UK

Tel: +44 (0) 1452 854212  
Email: info@agd-systems.com  
Web: agd-systems.com