

PRODUCT MANUAL

# AGD641

Pedestrian Detector

# TABLE OF CONTENTS

# AGD641

Pedestrian Detector

<b>INTRODUCTION</b>	<b>3</b>	<b>TECHNICAL RESOURCE</b>	<b>12</b>
Product and technology	3	Physical installation	12-15
Key features	3	Product Variants – Sun Shield Variant	16
Typical applications	3	<b>TROUBLESHOOTING</b>	<b>17</b>
Product overview image	4	Physical installation	17
Product variants	4	Electrical installation	17
Product overview	4	Connecting / Commissioning	17
<b>INSTALLATION AND COMMISSIONING</b>	<b>5</b>	<b>TECHNICAL SPECIFICATIONS</b>	<b>18</b>
Physical Installation	5	Product Dimensions	18
Step 1 – Mounting height	5	Specification	18
Step 2 – Detector alignment	5	<b>END OF LIFE DOCUMENT</b>	<b>19</b>
Step 3 – Detector view	5	<b>IMPORTANT SAFETY INFORMATION</b>	
Electrical Installation	6	Safety precautions	20
Connections	6	Low power non-ionising radio transmission and safety	20
Opto-Coupler Ratings	6	<b>CERTIFICATES</b>	<b>21</b>
Power Up Sequence	6	<b>DISCLAIMER</b>	<b>22</b>
Connecting	7	Warranty	22
Connecting Wifi	7	Contact Details	22
Connecting device	7		
Set-up device using Wifi AGD Touch-setup	8		
Step 1 – Name site	8		
Step 2 – Set zone	8-9		
Step 3 – Calibrate	10		
Home page	10-11		
Optional Parameters	11		



## AGD TOUCH

WiFi 3 Click Setup

# INTRODUCTION

## PRODUCT AND TECHNOLOGY

The AGD641 Pedestrian Detector has been designed for the detection and monitoring of pedestrians and cyclists waiting to cross the road to ensure the crossing phase is only called when they are present in the wait area.

The AGD641 is a replacement for the AGD640 Pedestrian Detector which has successfully been deployed on over 15,000 sites worldwide. The ground-up development of the 641 is a 3D stereo-vision optical system capable of detecting moving and stationary targets over a 4m x 2m zone. The 641 maintains class leading shadow and unwanted object rejection.



## KEY FEATURES

- 4m x 2m zone adjacent to the detector saving on infrastructure costs.
- AGD 3D optical stereo vision technology provides greater performance even at low light levels.
- WiFi AGD Touch-setup technology with 3 step browser setup speeds up installation and reduces installer risk.
- Flexible polygon tool allows easy configuration of curved or irregular detection zones saving time on site.
- Compatibility with old and new controllers makes the AGD641 an ideal solution for any site.
- In built Infra-red illuminator.

## TYPICAL APPLICATIONS

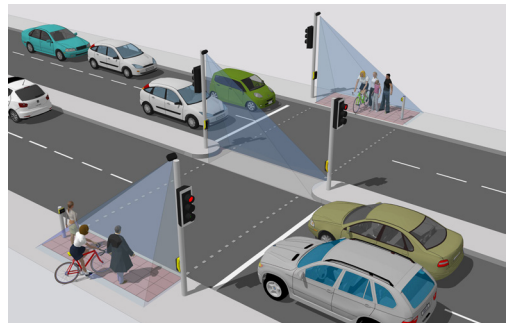

4m x 2m Toucan Crossing

# AGD641

Pedestrian Detector

# INTRODUCTION

# AGD641

Pedestrian Detector

## PRODUCT OVERVIEW IMAGE

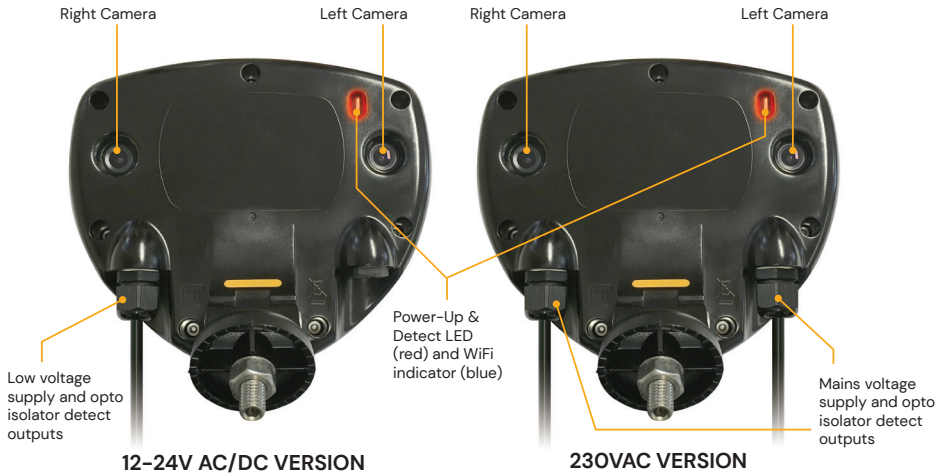

## PRODUCT VARIANTS

Product No.	Description
641-500-021	Pedestrian Detector / 12-24V ac/dc / WiFi / Single Opto Output/1m lead / 1m bulkhead mating lead
641-503-021	Pedestrian Detector / 12-24V ac/dc / WiFi / Single Opto Output / 5m flying lead
641-504-021	Pedestrian Detector / 12-24V ac/dc / WiFi / Single Opto Output / 1m lead / 4m bulkhead mating lead
641-300-021	Pedestrian Detector / 230Vac / WiFi / Single Opto Output / 5m flying leads
641-301-021	Pedestrian Detector / 230V ac / Wi-Fi / Single Opto Output / 5m flying leads / Sunshield
641-501-021	Pedestrian Detector / 12/24V ac/dc / Wi-Fi / Single Opto Output/ 5m flying lead / Sunshield

## PRODUCT OVERVIEW

The AGD641 Pedestrian Detector is an optical product that makes pedestrian crossings safer by delivering robust detection within a standard crossing zones. Multiple units easily integrate to cover larger wait areas.

It is a high-performance product that processes information on board with a new chip-set and sophisticated algorithms, automating decision-making to provide ultra-reliable detection.

The AGD641 Pedestrian Detector employs a 3D stereo vision optical system that detects moving and stationary targets over a 4 x 2m zone. It has an outstanding capability to detect people while rejecting shadows, litter, leaves and small objects such as birds walking through the zone.

It has Infra-red illumination for night time operation.

## PHYSICAL INSTALLATION

### STEP 1 – MOUNTING

**HEIGHT** – The AGD641 Pedestrian Detector has excellent performance when mounted between heights of **3–4 metres**.

If you have an application whereby you wish to mount the detector outside of these heights, then please contact AGD.

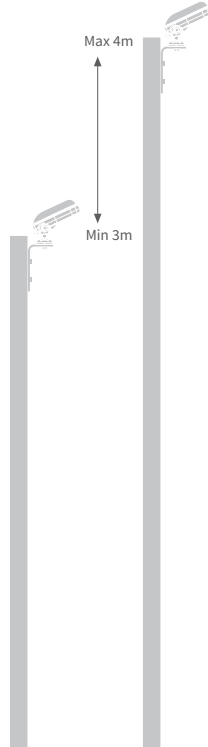

**STEP 2 – DETECTOR ALIGNMENT** – The AGD641 Pedestrian Detector should be mounted using the supplied hardware. Adjust the tilt angle to align the mark highlighted in the image below, adjustments of  $\pm 15$  degrees can be made ensure a point 4m from the base of the pole can be seen by the detector. Ensure that the detector is securely fixed and the mounting nut is tight.

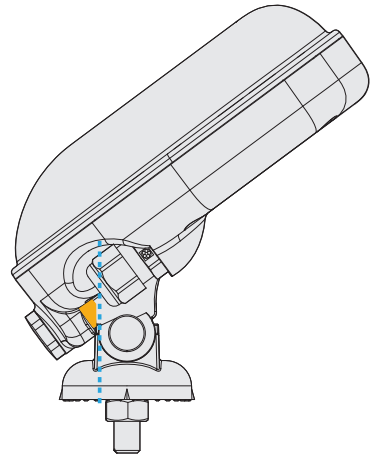

**STEP 3 – DETECTOR VIEW** – View the zone-area from the detector, including the area directly in front of the push button. Obstruction of the zone-area by signal head backing boards, moving foliage or anything else **must** be avoided so that the detector has a clear field of view.

**Detector Alignment** – Further adjustment may be required in occasional circumstances to accommodate particular site conditions.

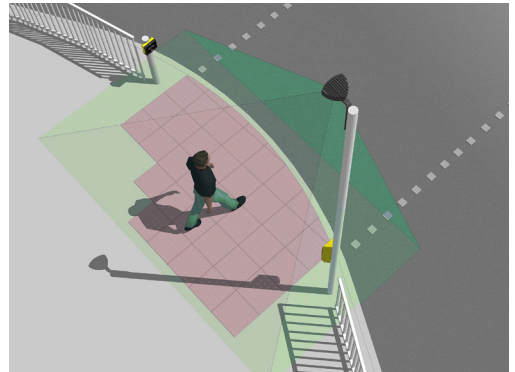

## ELECTRICAL INSTALLATION

The detector is powered using a 12–24V ac/dc ( $\pm 20\%$ ) or 230Vac supply. For the non mains units the power is applied to the detector using the multi-pin mating connector.

The AGD641 Pedestrian Detector is provided with a Buccaneer Series PX0728/S 9 pole connector to enable direct connection to the traffic control system. The pin outs of the connector and detector function are highlighted in the table below:

## CONNECTIONS

Pin No.	Pin Colour	Function	Power Off	Power On- No Detect	Power On- Detect	Notes
1	RED	12–24V ac/dc	-	-	-	-
2	BLACK	0Vac/dc	-	-	-	-
3	GREEN	Earth/Ground	-	-	-	-
4	WHITE	Opto 1/2 Common	-	-	-	-
5	YELLOW	Opto 1 N/O	N/O	N/C	N/O	-
6	BLUE	Opto 1 N/C	N/C	N/O	N/C	Not for use on Puffins/Toucans
7	-	-	-	-	-	-
8	BROWN	Not Connected	-	-	-	-
9	VIOLET	Not Connected	-	-	-	-

## CONNECTIONS FOR 230VAC VERSION

### Twin Cable 230Vac Supply Wiring (5m flying leads)

Cable	Wire Colour	Function	Power Off	Power On – No Detect	Power On –Detect
Power	Brown	230Vac Live	-	-	-
	Blue	230Vac Neutral	-	-	-
Signal	White	Opto Common	-	-	-
	Blue	Opto Contact	N/C	N/O	N/C
	Yellow	Opto Contact	N/O	N/C	N/O

## OPTO-COUPLER RATINGS FOR ALL VOLTAGE VERSIONS

- Max current 60mA
- Max Voltage 100V
- Max on-state impedance 25 Ohms

Power supply ratings	12Vac	24Vdc	24Vac	230Vac
Day time mode	-	-	170mA	17mA
Night time mode	300mA	140mA	200/255mA	24/30mA

## POWER UP SEQUENCE

After applying power to the unit, the front red LED will permanently illuminate for approximately 30 secs while the operating system loads. The LED will then start flashing and either extinguish if the detector has been previously set-up and revert to normal operation (illuminated if zone is in detect, not illuminated if zone is empty), or the LED will continue to flash until the unit has been set-up and commissioned.

## CONNECTING

The AGD641 Pedestrian Detector has been designed with efficiency and ease of use in mind. User connect to the detector using a WiFi enabled device (laptop, tablet or phone) and set up simply using a browser window.

This step-through process describes the actions required to set up the detector upon initial deployment when first removed from the box.

### CONNECTING WIFI

Check the red LED is illuminated and flashing on the front of the unit. Search for the unit and identify the unit by its **serial number**:

**641:XXXXXX-XXXX-TBD** (the 'X' denotes the S/N, TBD is a renamable field used to name the pole location the 641 is installed on)

Click 'connect' and input the **default password**:

**Agd641:XXXXXX-XXXX** (the 'X' denotes the S/N)

The LED on the front of the unit should now be illuminated blue to show WiFi is successfully connected and your device should show connected.

AGD Systems recommend you change the password via the Advanced screen option.

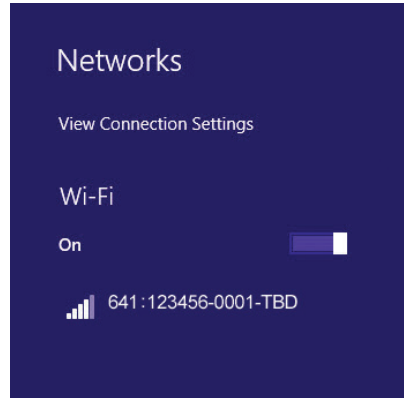

### CONNECTING DEVICE

Complete Wifi connection step as above.

Launch a browser on your smartphone, tablet or laptop (Modern versions of Google Chrome are supported – 2018 onwards).

In the address bar of your browser, enter the 'IP Address': **http://10.42.0.1:8080**

You will be presented with your initial AGD Touch-setup page.

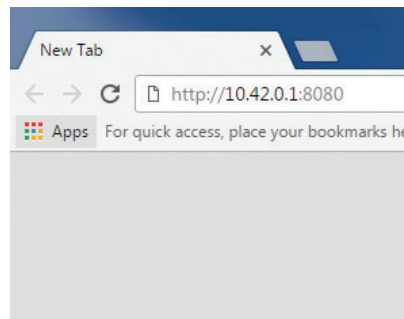

## SET-UP DEVICE USING AGD TOUCH-SETUP

When logged in to the device for the first time you click set-up. This is the AGD Touch-Setup, a three stage process that allows installers to configure the device quickly and efficiently.

### STEP 1 – NAME SITE

The first action is to name the devices '**Install Location**'.

\*Note – No space within text is permitted, this will change the SSID of the device (the Wifi name of the device). However, the default password will remain the same unless changed in 'Advanced' settings

When finished naming the '**Install Location**' proceed to the next step by clicking '**Next**'.

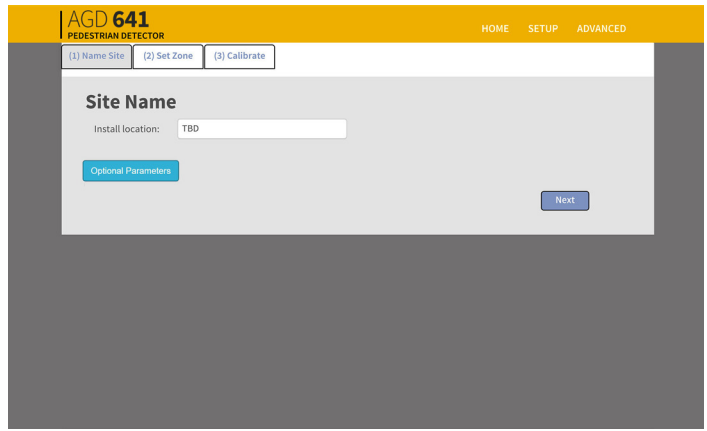

### STEP 2 – SET ZONE

The second action is to '**Set Zone**' using the quick-mask 'zone' tool. Draw a boundary around the area in which you are interested in detecting pedestrians. Take care to draw around poles, railings, foliage and other items that might be in the field of view.

Note the extra area that has been drawn around the tactiles, this is necessary to provide coverage at the extremities of the zone.

Continued over page.

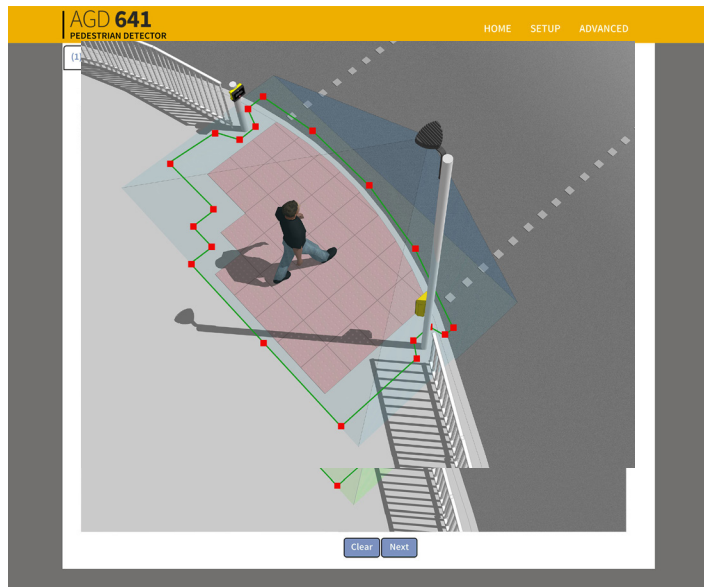



## STEP 2 – SET ZONE (CONTINUED)

On the extremities of the zone it is essential that you extend its coverage past the point at which the AGD641 needs to detect. The detection floor starts at **0.6m** meaning the zone has to be extended out to ensure enough of the pedestrian's body is in the zone above the 0.6m threshold.

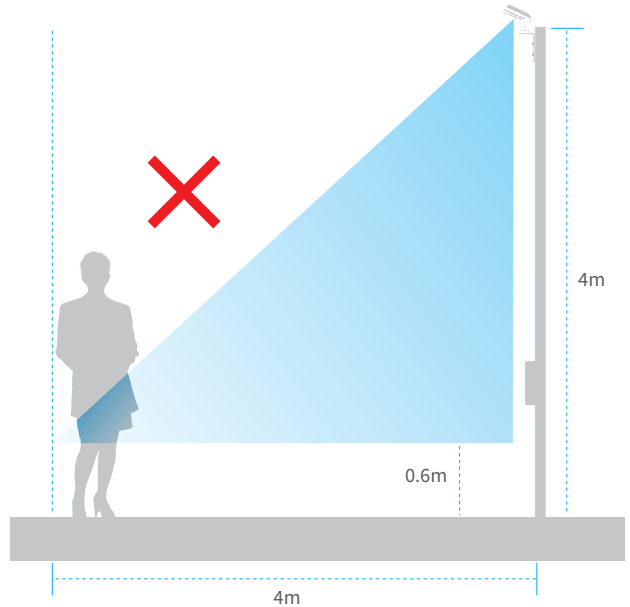

A **1m** extension is often required to ensure enough of the pedestrian is seen on the far side of the detection zone above the **0.6m** threshold.

**Please note:** The maximum range of the AGD641 will still be **4m**, extending the zone helps the detector to see the body of a pedestrian.

When the zone is set, click **'Next'**.

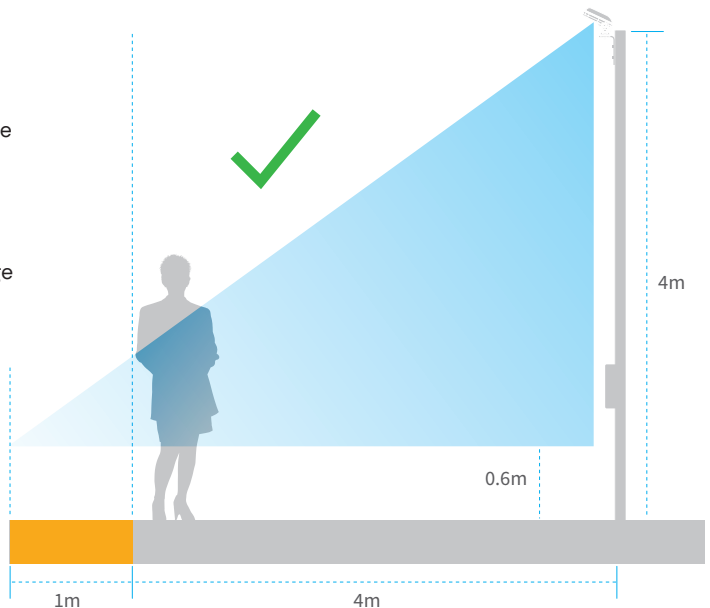

## STEP 3 – CALIBRATE

The third and final stage in the set-up is 'Calibration'. Check the selected zone-area, ensure the zone is empty, then click 'On-Site Calibration'.

Successful completion of the calibration will result in the detector returning to the 'Home' page.

Note: If someone walks into the zone whilst calibrating, please carry out this step again.

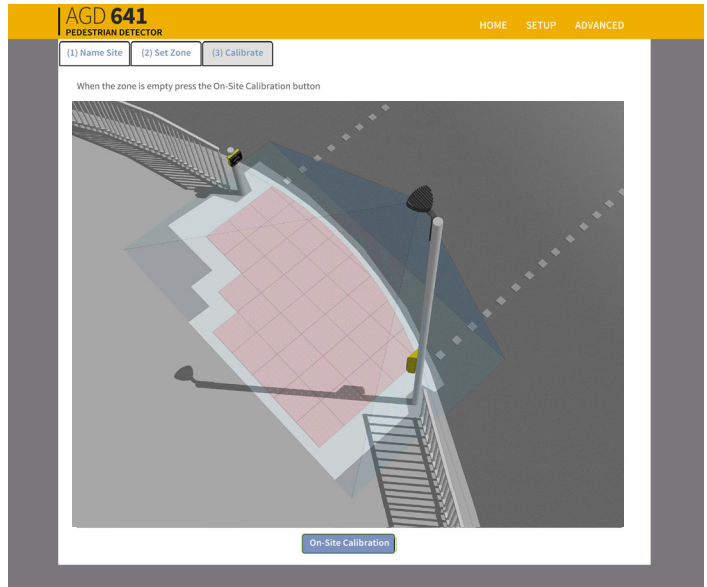

## HOME PAGE

Following successful calibration you will view your selected zone actively 'detecting' on the 'Home Page' - and helpfully, if the detector has been previously setup you will come straight to the Home Page on connection.

The image you see on the screen will be the detect area with any area excluded greyed out. This image will update periodically.

Monitor the zone and check the detector triggers - the front LED will illuminate and extinguish when someone enters and leaves the zone.

A box around the image will illuminate **RED** on Detection.



## HOME PAGE

An example of what you will see once step 1, 2 and 3 has been completed correctly.

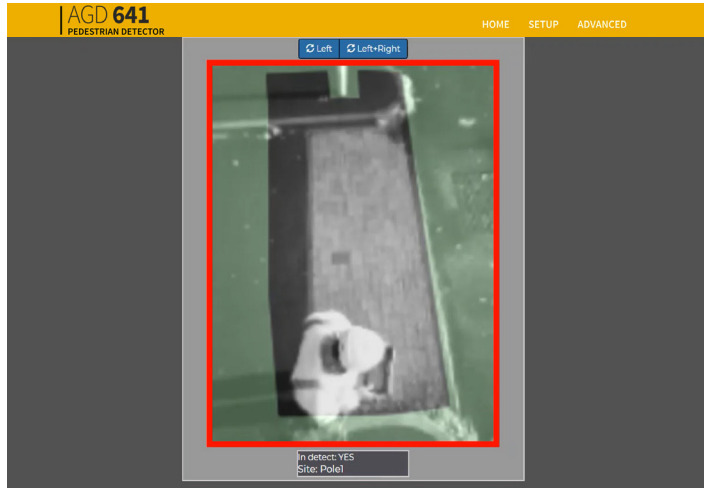

## OPTIONAL PARAMETERS

**WiFi Channel** – Select WiFi channel. Used only in special circumstances where WiFi channels are very busy and causing interference.

**Wifi off after** – Select how long you would like the WiFi to stay on after you have disconnected. The device will need to be power cycled to have the WiFi network viewable after the selected period.

**Detect LED on at night** – Select this to allow the detector to illuminate the front RED led at night.

**Delay Time (sec)** – The delay feature allows the AGD641 to operate as a passive detector when paired with the correct equipment/programming. When the default configuration (0 seconds) is set the AGD641 changes the output state immediately upon a valid target detection. The 'Delay Time' function introduces a user selectable delay of 0–20

seconds that allows the user to select the most appropriate value (according to site topography) that will ignore pedestrians transitioning through the detection zone and only detect those waiting to cross safely.

E.g. if a 5 second delay is selected, the AGD641 output will NOT activate until a valid target enters and remains in the detection zone for 5 seconds.

Please note: Any changes to 'Delay Time' value will also require a detector reboot to implement changes.

**Hold Time (sec)** – This value denotes the amount of time the detection OPTO output is held **AFTER** a valid target leaves the area of detection. **Input range** = 0 – 60 seconds. **Default** = 2 seconds

**User notes** – An editable field to allow engineers to store notes in the device. **Max characters** = 64 bytes

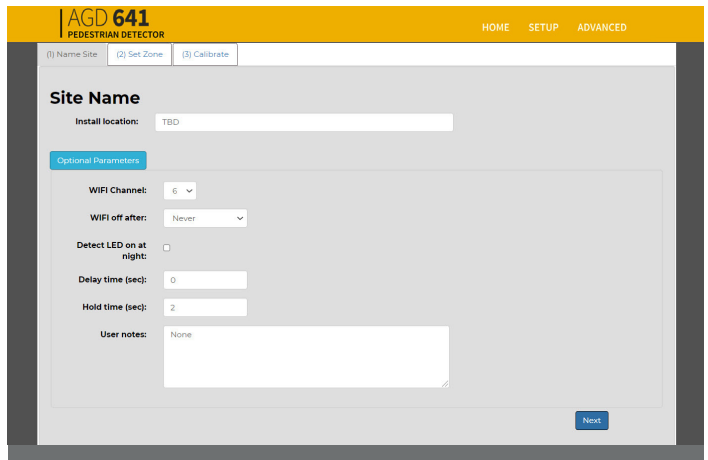

Conversion Table	
1m = 3.3ft	1ft = 0.3m
Popular Mounting Heights	Popular Range Measurements
m = ft	m = ft
2.0 = 6.6	5 = 16.5
2.5 = 8.3	10 = 33.0
3.0 = 9.9	15 = 49.5
3.5 = 11.6	20 = 66.0
4.0 = 13.2	25 = 82.5
4.5 = 14.9	50 = 165.0
5.0 = 16.5	100 = 330.0
5.5 = 18.2	150 = 495.0
6.0 = 19.8	180 = 594.0

**Please Note:** The table above is a generic meters to feet conversion table to aid international customers.

For product specific mounting heights and detection ranges, please refer to the relevant sections of this product manual.

## PHYSICAL INSTALLATION

### TYPICAL INSTALLATION PARAMETERS

The AGD641 operates with a high degree of accuracy when mounted inside normal parameters.

The following 3 diagrams over subsequent pages show a plan view of the expected coverage of the stereo cameras when the detector is mounted at different heights.

\*Note - To gain the full 2m width the 641 must be located in the centre of the wait area, the highlighted areas display the may detect zones.

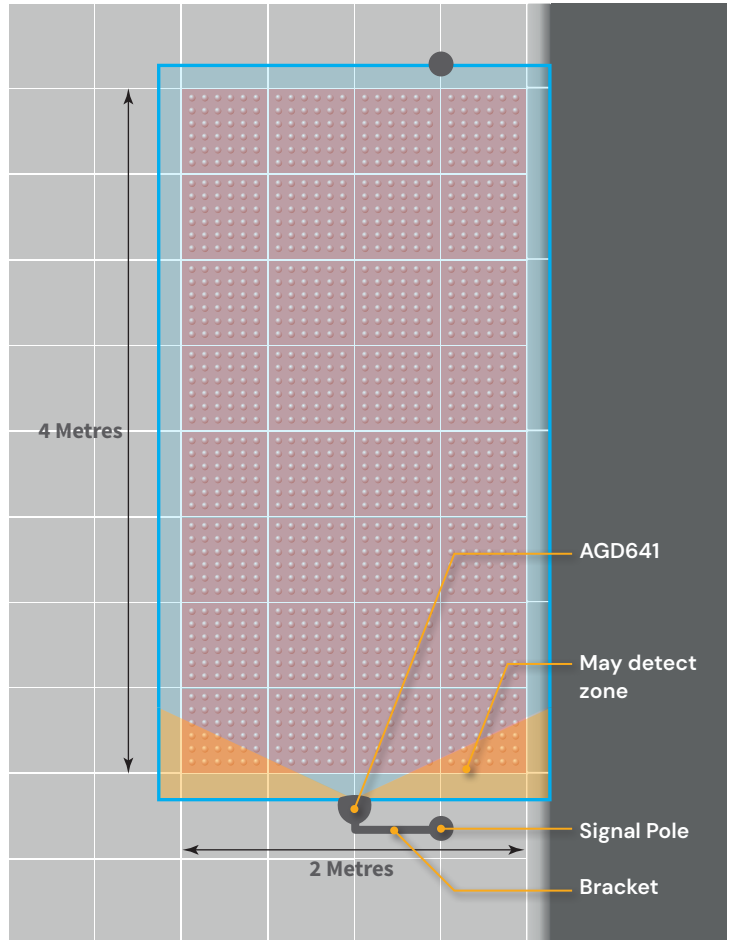

▲ **4m x 2m Zone** - Illustrated zone size when the detector is mounted at 4m

PHYSICAL INSTALLATION

TYPICAL INSTALLATION PARAMETERS

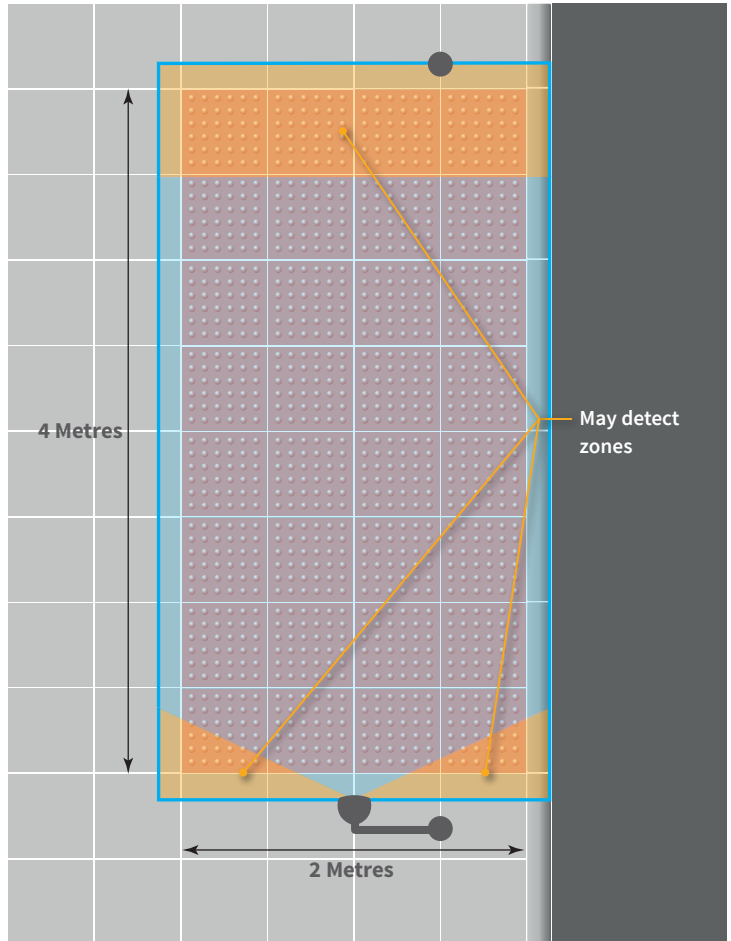

▲ 4m x 2m Zone - Illustrated zone size when the detector is mounted at 4m

PHYSICAL INSTALLATION

TYPICAL INSTALLATION PARAMETERS

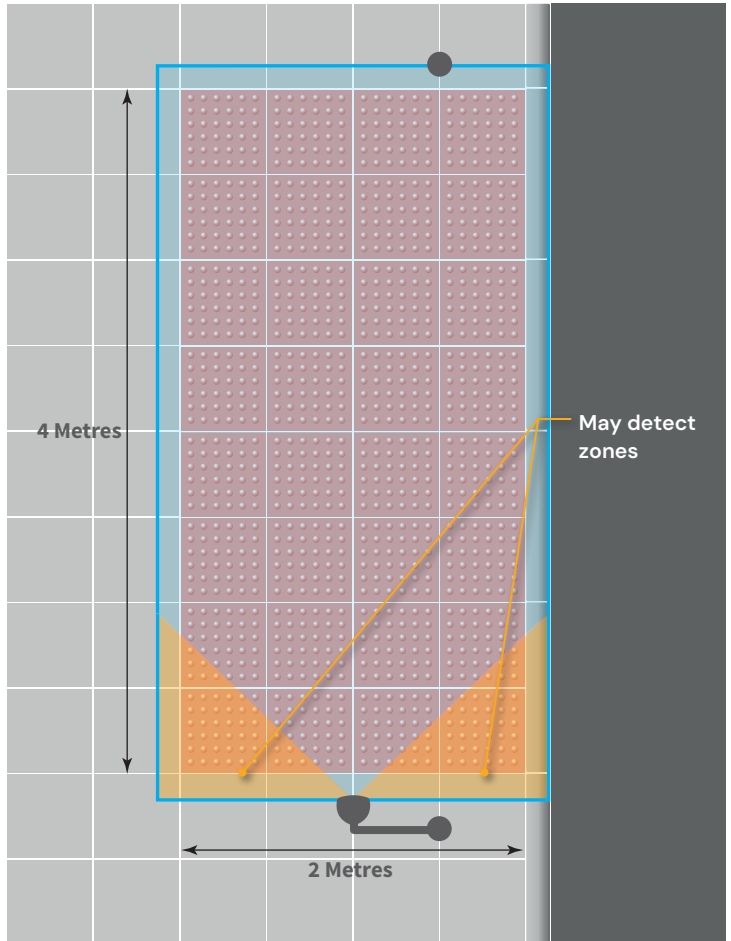

▲ 4m x 2m Zone - Illustrated zone size when the detector is mounted at 3m (mounting angle increased +15% to gain extra length)

PRODUCT VARIANT

SUN SHIELD VARIANT

Product no. 641-301-021 / 641-501-021

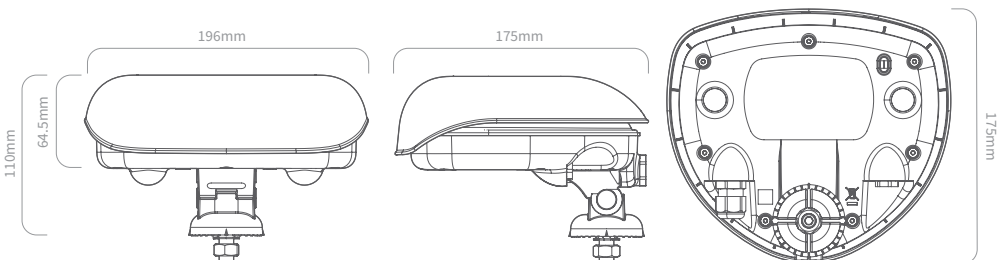

SPECIFICATIONS

**Dimensions** W 196mm x D 175mm x H 110mm

**Weight** 620g



## PHYSICAL INSTALLATION

If the unit is not operating correctly, please check the following. Has the unit been:

- 1) Mounted within the recommended height of 3 – 4 metres?
- 2) Angled according to the installation guide to provide good coverage of the detection area?
- 3) Installed with any obstructions in the viewable area such as the traffic signal head?

## ELECTRICAL INSTALLATION

If the unit is not operating correctly, please check the following:

- 1) Is power present at the unit?
- 2) Is the red LED illuminated when power is applied to the unit?
- 3) Is there sufficient current to run the unit – identified by the red LED failing to flash or flashing only once during power-up and the web page not starting correctly? Refer to technical specification table.

## CONNECTING / COMMISSIONING

If the unit is not operating in the prescribed manner, please check the following:

- 1) Is the LED on the front of the unit you wish to connect to illuminated blue to show that the WiFi network is successfully connected?
- 2) Has the correct IP Address been entered into the browser address bar?
- 3) Have you followed the AGD Touch-setup stages correctly and verified correct operation?

If trouble with any operations persist, please contact AGD Technical Support.

## AGD TECHNICAL SUPPORT

eMail: [technical@agd-systems.com](mailto:technical@agd-systems.com)

Tel: +44-1452-557404

## PRODUCT DIMENSIONS

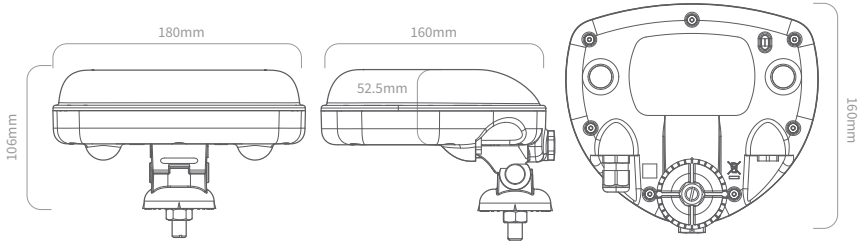

## SPECIFICATIONS

Description	Pedestrian Detector
Technology	AGD 3D HD Optical Stereo Vision
Detection Zone	4m x 2m (mounted @4m)
Mounting Height	3-4m (3.5m nominal)
Power Supply	12 - 24V ac/dc or 230Vac
Power	3.6W @ 12Vdc @ 300mA / 6.9W @ 230Vac @ 30mA 6.1W @ 24Vac @ 255mA / 3.4W @ 24Vdc @ 140mA
WiFi Frequency/Power	Frequency range (MHz): 2412-2472 Highest EIRP power in the range (dBm): 19.7
Opto / Relay Current	60mA
Detect Output	Single Opto
LED Indication	Front LEDs for detect and WiFi connection
Housing Material	Black Polycarbonate
Sealing	IP55 & NEMA 250 4X
Operating Temp	-34°C to +74°C
Configuration	WiFi AGD Touch-Setup
Lux Level	In built IR illuminator for low light/nighttime
Dimensions	W 181mm x D 160mm x H 106mm
Weight	500g
Complies with	EMC: BS EN 50293:2012, EN 301 489-17, EN 301 489-1 Health & Safety: BS EN 62368, EN 60950-22, EN 62311 Spectrum: EN 300 328 RoHS: EN 50581 Other: TOPAS 2507A, NEMA TS 2 2016
Patent No.	GB 2448617



\*For US special build variant required  
Owing to the Company's policy of continuous improvement, AGD Systems Limited reserves the right to change their specification or design without notice.

# END OF LIFE

# AGD641

Pedestrian Detector

## DISPOSAL INSTRUCTIONS (EOL)

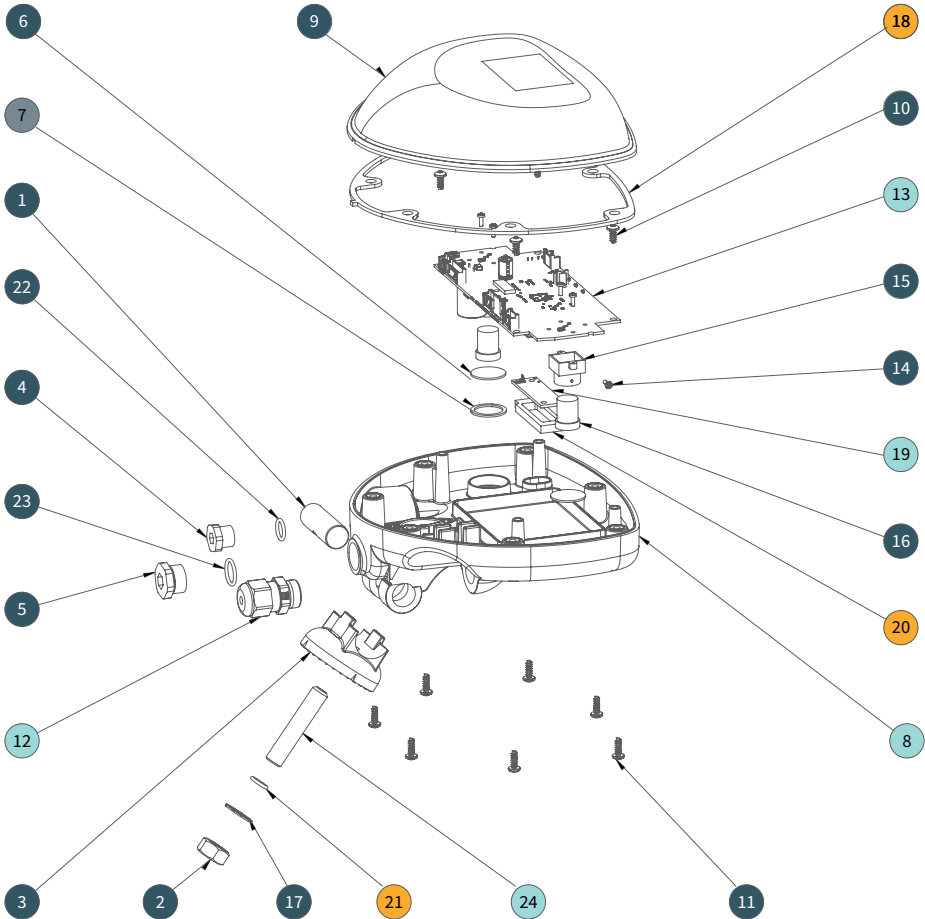

Item	Qty	Material
1	1	Aluminium
2	1	Stainless Steel
3	1	Polycarbonate
4	1	Nylon
5	1	Nylon
6	2	Glass
7	2	HSAP
8	1	Polycarbonate

Item	Qty	Material
9	1	Polycarbonate
10	4	Stainless Steel
11	7	Stainless Steel
12	1	Metal, Nylon, & PVC
13	1	Printed Circuit board
14	6	Stainless Steel
15	2	Aluminium
16	2	Mixed Metal & Glass

Item	Qty	Material
17	1	Stainless Steel
18	1	Neoprene
19	1	Printed Circuit board
20	1	Nylon
21	1	Nitrile
22	1	EPDM
23	1	EPDM
24	1	Stainless Steel

- Reuse / Recycle
- Separate & Recycle
- Downcycle
- Hazardous Recovery
- Non-Recyclable

## IMPORTANT

AGD641

Pedestrian Detector

### SAFETY PRECAUTIONS

All work must be performed in accordance with company working practices, in-line with adequate risk assessments. Only skilled and instructed persons should carry out work with the product. Experience and safety procedures in the following areas may be relevant:

- **Working with mains power**
  - **Working with modern electronic/electrical equipment**
  - **Working at height**
  - **Working at the roadside or highways**
1. This product is compliant to the Restriction of Hazardous Substances (RoHS – European Union directive 2011/65/EU).
  2. The product must be correctly connected to the specified power supply. All connections must be made whilst the power supply is off or suitably isolated. Safety must always take precedence and power must only be applied when deemed safe to do so.
  3. No user-maintainable parts are contained within the product. Removing or opening the outer casing is deemed dangerous and will void all warranties.
  4. Under no circumstances should a product suspected of damage be powered on. Internal damage may be suggested by unusual behaviour, an unusual odour or damage to the outer casing. Please contact AGD for further advice.
  5. This Product is Compliant with the European Radio Equipment Directive 2014/53/EU. There are no restrictions of use within any EU Member state for this product. This product is Receiver Category 2.





Traffic Open Products and Specifications

CERTIFICATE OF REGISTRATION

Company: AGD Systems Limited

We confirm that the products listed below have been registered with TOPAS Limited under reference 2019/0155 and meet the requirements provided under TOPAS 0600 and the TOPAS Specifications applicable.

Product Name: 641 Pedestrian Detector

Product Reference: 641

TOPAS Specifications: TOPAS 2507A

Exceptions/Limitations: Clause 2.20 & 2.27 (see below)

Director, Dr M E Pleydell

Signed.....  
(on behalf of Traffic Open Products and Specifications Limited)

Dated.....  
8/3/19

Website: [www.topasgroup.org.uk](http://www.topasgroup.org.uk)  
Email: [enquiries@topasgroup.org.uk](mailto:enquiries@topasgroup.org.uk)

TOPAS accepts no liability as to the compliance of this product other than as stated on the register of products at [www.topasgroup.org.uk](http://www.topasgroup.org.uk) Procurers are advised to confirm compliance of statutory regulations with the manufacturer.

Page 1 of 2

Registered at Companies House Cardiff Number : 9132907  
Registered Office: The Apex, 2 Sheriffs Orchard, Coventry CV1 3PP

2019/0155

# DISCLAIMER

While we (AGD Systems) endeavour to keep the information in this manual correct at the time of download or print, we make no representations or warranties of any kind, express or implied, about the completeness, accuracy, reliability, suitability or availability with respect to the information, products, services, or related graphics contained herein for any purpose.

Any reliance you place on such information is therefore strictly at your own risk. In no event will we be liable for any loss or damage including without limitation, indirect or consequential loss or damage, or any loss or damage whatsoever arising from loss of data or profits arising out of, or in connection with, the use of this manual.

## Warranty

All AGD products are covered by a 12 month return to factory warranty. Products falling outside this period may be returned to AGD Systems for: evaluation, repair, update or re-calibration, any of which may be chargeable.

Revision
Issue 5 April 2023



**AGD**<sup>®</sup> | SAFER  
GREENER  
MORE EFFICIENT

### **AGD Systems Limited**

White Lion House, Gloucester Road,  
Cheltenham, GL51 0TF, UK

**Tel:** +44 (0) 1452 854212

**Email:** [info@agd-systems.com](mailto:info@agd-systems.com)

**Web:** [agd-systems.com](http://agd-systems.com)