

PRODUCT MANUAL

AGD645

Pedestrian Detector

TABLE OF CONTENTS

AGD645

Pedestrian Detector

INTRODUCTION	3	TECHNICAL RESOURCE	12
Product and technology	3	Physical installation	12 - 13
Key features	3	Electrical installation	14-15
Typical applications	3	Connecting / Commissioning	16-18
Product overview image	4		
Product Variants	4	TROUBLESHOOTING	19
Product overview	4		
INSTALLATION AND COMMISSIONING	5	TECHNICAL SPECIFICATIONS	20
Physical Installation	5	Product Specification	20
Step 1 – Mounting height	5		
Step 2 – Detector alignment	5	END OF LIFE DOCUMENT	21
Step 3 – Detector view	5		
Electrical Installation	6	IMPORTANT SAFETY INFORMATION	
Connections	6	Safety precautions	22
Ethernet Connector Type	6		
Opto-Coupler Ratings	6	DISCLAIMER	23
Power Up Sequence	6	Warranty	23
Connecting	7	Contact Details	23
Connecting Wifi	7		
Connecting device	7		
Set-up device using Wifi AGD Touch-setup	8		
Step 1 – Name site	8		
Step 2 – Set zone	8 - 9		
Step 3 – Calibrate	10		
Home page	10 - 11		
Optional Parameters	11		



INTRODUCTION

AGD645

Pedestrian Detector

PRODUCT AND TECHNOLOGY

The AGD645 Pedestrian Detector has been designed for the detection and monitoring of pedestrians waiting to cross the road to ensure the crossing phase is called only when pedestrians are present.

The AGD645 builds on the popular AGD640 Pedestrian Detector which has successfully been deployed on over 15,000 sites worldwide. The ground-up development of the AGD645 is a 3D HD stereo-vision optical system capable of detecting moving and stationary targets over a large 10m x 3m zone. The 645 maintains class leading shadow and unwanted object rejection.

TYPICAL APPLICATIONS

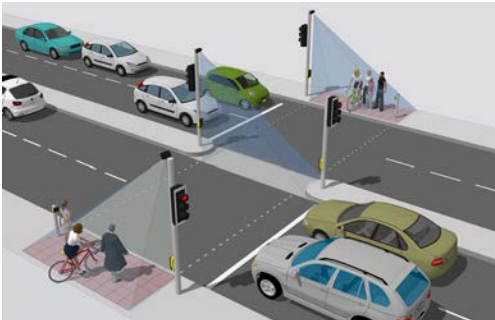

5m x 3m Toucan Crossing



10m x 3m Super Crossing using single units

KEY FEATURES

- 10m x 3m zone adjacent to the detector saving on infrastructure costs.
- AGD 3D HD optical stereo vision technology provides greater performance even at low light levels.
- Wifi AGD Touch-setup technology with 3 step browser setup speeds up installation and reduces installer risk.
- AGD Quick-mask zone selection allows easy configuration of curved or irregular detection zones saving even more time on site.
- IP remote access and live video functionality for greater access to site data improving safety of users.
- Compatibility with old and new controllers makes the AGD645 an ideal solution for any site.
- Occupancy mode allows dynamic extension of the green man invitation period when sites have a high volume of pedestrians waiting to cross.

INTRODUCTION

AGD645

Pedestrian Detector

PRODUCT OVERVIEW IMAGE

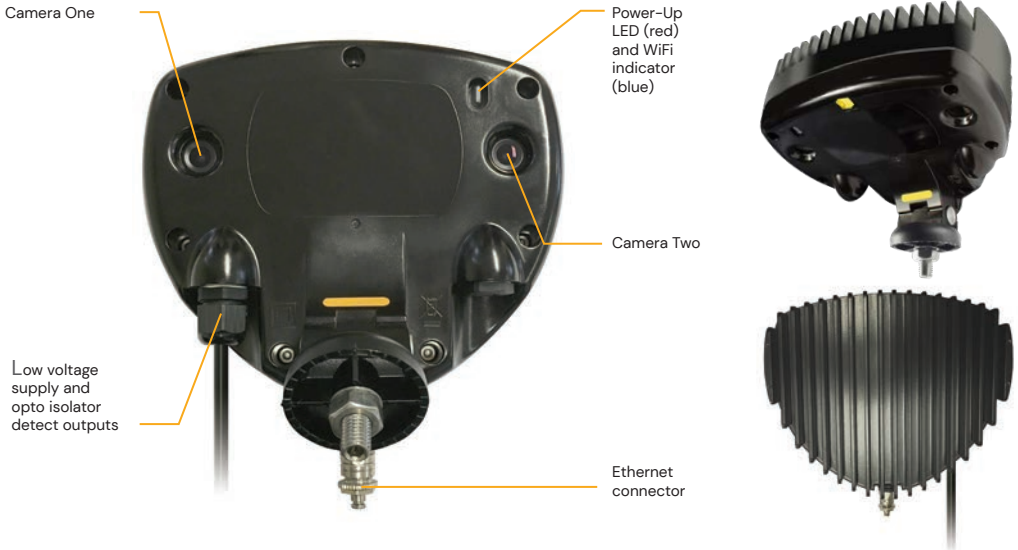

PRODUCT VARIANTS

645-200-000	Kerbside Detector / 24V / WiFi / Ethernet / Dual Opto Output/1m lead / 1m bulkhead lead
645-203-000	Kerbside Detector / 24V / WiFi / Ethernet / Dual Opto Output/5m flying lead
645-204-000	Kerbside Detector / 24V / WiFi / Ethernet / Dual Opto Output/1m lead / 4m bulkhead mating lead

PRODUCT OVERVIEW

The AGD645 Pedestrian Detector is an optical product that makes crossings safer by delivering robust detection within a larger zone than previously possible. Multiple units easily integrate to comfortably cover new style 'super-crossings'.

It is a high-performance product that processes information on board with a new chip-set and sophisticated algorithms, automating decision-making to provide ultra-reliable detection.

The AGD645 Pedestrian Detector employs a 3D HD stereo vision optical system that detects moving and stationary targets over a large 10m x 3m zone. It has an outstanding capability to detect people while rejecting shadows, litter, leaves and small objects such as birds walking through the zone.

Designed into the platform to cover the needs of 'Smart City' systems are IP, Power Over Ethernet, and real-time video capabilities which allow the 645 to feed data and pictures 'down the wire' straight into ITS control rooms – empowering truly informed decision making.

PHYSICAL INSTALLATION

STEP 1 – MOUNTING

HEIGHT – The AGD645 Pedestrian Detector has excellent performance when mounted between heights of **3–6 metres**.

If you have an application whereby you wish to mount the detector outside of these heights, then please contact AGD.

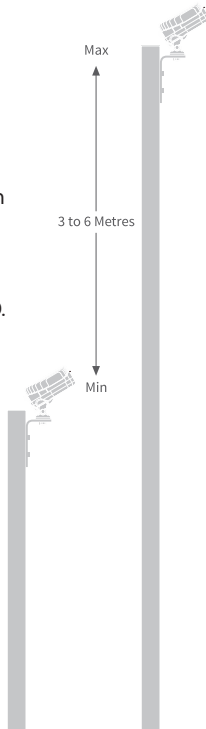

STEP 2 – DETECTOR ALIGNMENT – The AGD645 Pedestrian Detector should be mounted using the supplied hardware. Adjust the tilt angle so that the arrow marking on the housing and mounting foot line up (for 10m zone coverage, the unit must be tilted further back). Ensure that the detector is securely fixed and the mounting nut is tight.

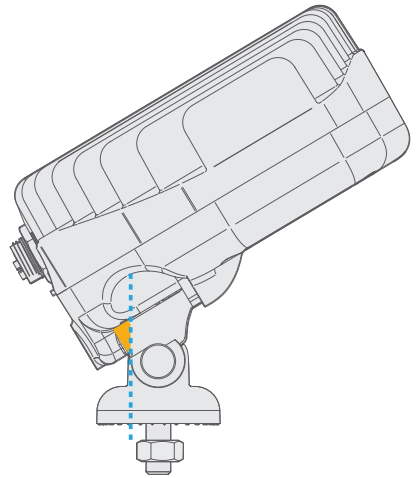

STEP 3 – DETECTOR VIEW – View the zone-area from the detector, including the area directly in front of the push button. Obstruction of the zone-area by signal head backing boards, moving foliage or anything else **must** be avoided so that the detector has a clear field of view.

Detector Alignment – Further adjustment may be required in occasional circumstances to accommodate particular site conditions.

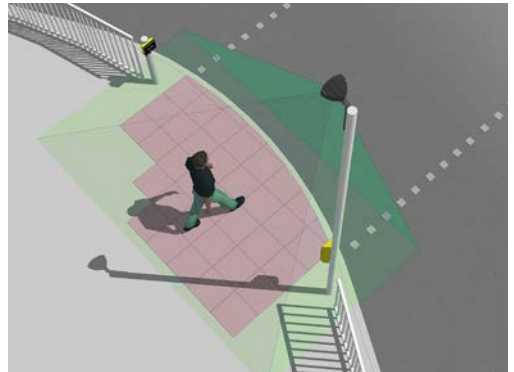

ELECTRICAL INSTALLATION

The detector is powered using a 24V AC / DC ($\pm 20\%$) supply. The power is applied to the detector using the multi-pin mating connector.

The AGD645 Pedestrian Detector is provided with a Buccaneer Series PXO728/S 9 pole connector to enable direct connection to the traffic control system. The pin outs of the connector and detector function are highlighted in the table below:



CONNECTIONS

Pin No.	Pin Colour	Function	Power Off	Power On- No Detect	Power On- Detect	Notes
1	RED	+24V AC/DC	-	-	-	-
2	BLACK	0V AC/DC	-	-	-	-
3	GREEN	Earth/Ground	-	-	-	Must be connected
4	WHITE	Opto 1/2 Common	-	-	-	-
5	YELLOW	Opto 1 N/O	N/O	N/C	N/O	-
6	BLUE	Opto 1 N/C	N/C	N/O	N/C	Not for use on Puffins/Toucans
7	-	Not Connected	-	-	-	-
8	BROWN	Opto 2 N/O	N/O	N/C	N/O	*Only for use with Occupancy*
9	VIOLET	Opto 2 N/C	N/C	N/O	N/C	

ETHERNET CONNECTOR TYPE

Please see Technical Resource Section.

OPTO-COUPLER RATINGS

- Max current 100mA
- Max Voltage 100V
- Max on-state impedance 25 Ohms

POWER UP SEQUENCE

After applying power to the unit, the front red LED will permanently illuminate for approximately 30 secs while the operating system loads. The LED will then start flashing and either extinguish if the detector has been previously set-up and revert to normal operation (illuminated if zone is in detect, not illuminated if zone is empty), or the LED will continue to flash until the unit has been set-up and commissioned.

CONNECTING

The AGD645 Pedestrian Detector has been designed with efficiency and ease of use in mind. It is connected to using a WiFi enabled device (laptop, tablet or phone) and setup simply using a browser window.

This step-through process describes the actions required to setup the detector upon initial deployment when first removed from the box.

CONNECTING WIFI

Check the red LED is illuminated and flashing on the front of the unit. Search for the unit and identify the unit by its **serial number**:

645:XXXXXX-XXXX-TBD (the 'X' denotes the S/N, TBD is a renamable field used to name the pole location the 645 is installed on)

Click 'connect' and input the **default password**:

Agd645:XXXXXX-XXXX (the 'X' denotes the S/N)

AGD Systems recommend you change the password via the Advanced screen option.

The LED on the front of the unit should now be illuminated blue to show WiFi is successfully connected and your device should show connected.

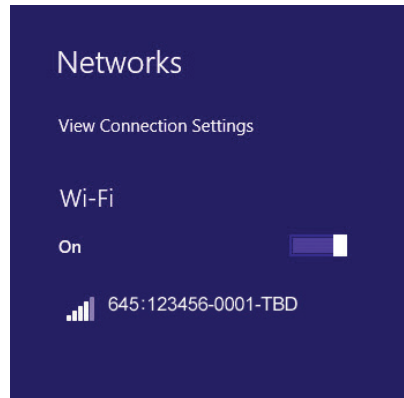

CONNECTING DEVICE

Complete Wifi connection step as above.

Launch a browser on your smartphone, tablet or laptop (Modern versions of: Internet Explorer, Google Chrome and Safari are all supported - 2016 onwards).

In the address bar of your browser, enter the 'IP Address': **http://10.42.0.1:8080**

You will be presented with your initial AGD Touch-setup page.

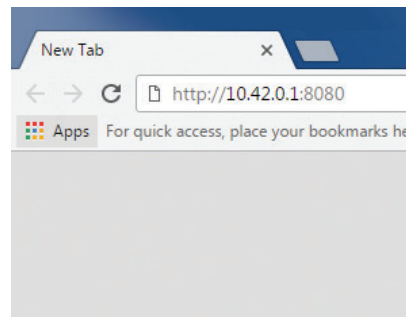

SET-UP DEVICE USING AGD TOUCH SETUP

The AGD645 Pedestrian Detector has been designed with efficiency and ease of use in mind. It is connected to using a WiFi enabled device (laptop, tablet or phone) and setup simply using a browser window.

This step-through process describes the actions required to setup the detector upon initial deployment when first removed from the box.

STEP 1 – NAME SITE

The first action is to name the devices **'Install Location'**.

*Note – This will change the SSID of the device (the Wifi name of the device). However, the default password will remain the same unless changed in 'Advanced' settings

When finished naming the **'Install Location'** proceed to the next step by clicking **'Next'**.

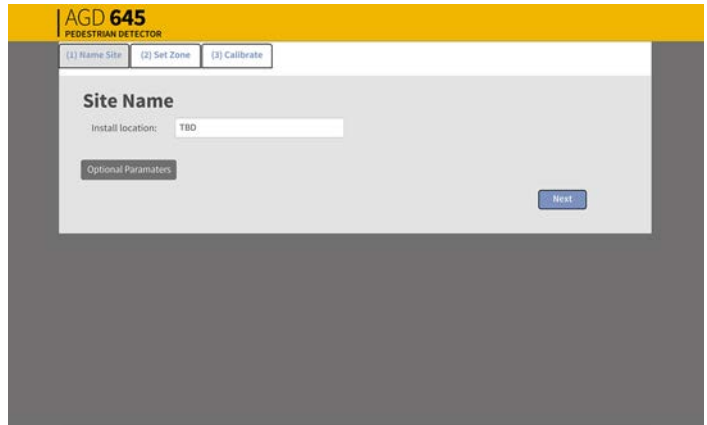

STEP 2 – SET ZONE

The second action is to **'Set Zone'** using the quick-mask 'zone' tool. Draw a boundary around the area in which you are interested in detecting pedestrians. Take care to draw around poles, railings, foliage and other items that might be in the field of view.

Note the extra area that has been drawn around the tactiles, this is necessary to provide coverage at the extremities of the zone.

Continued over page.

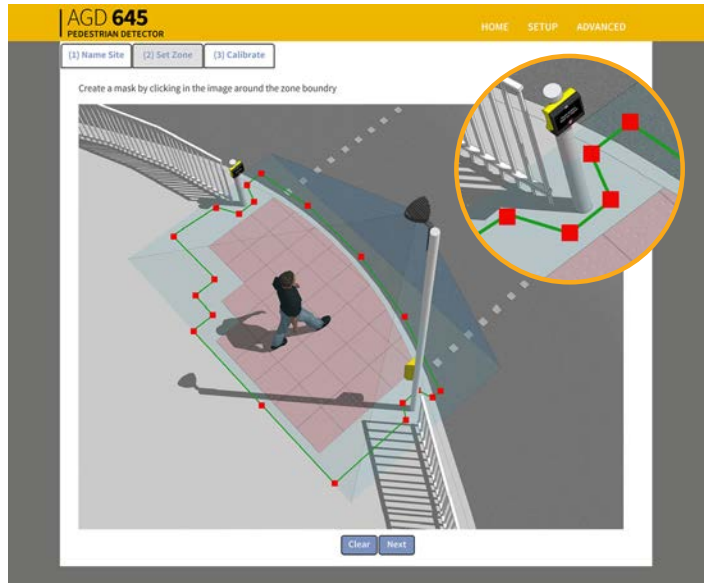

STEP 2 – SET ZONE (CONTINUED)

On the extremities of the zone it is essential that you extend its coverage past the point at which the AGD645 needs to detect. The detection floor starts at **0.6m** meaning the zone has to be extended out to ensure enough of the pedestrian's body is in the zone above the 0.6m threshold.

In this example the 645 is being set-up to cover a 4m zone.

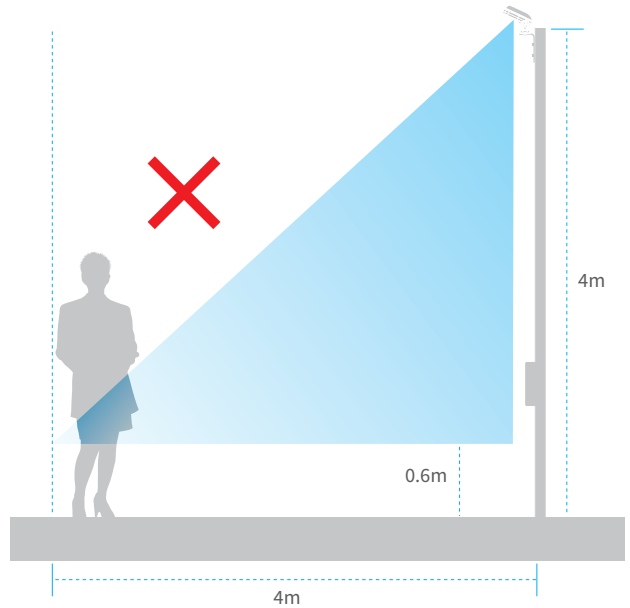

A **1m** extension is often required to ensure enough of the pedestrian is seen on the far side of the detection zone above the **0.6m** threshold.

Please note: The maximum range of the AGD645 will still be **10m**, extending the zone helps the detector to see the body of a pedestrian.

When the zone is set, click **'Next'**.

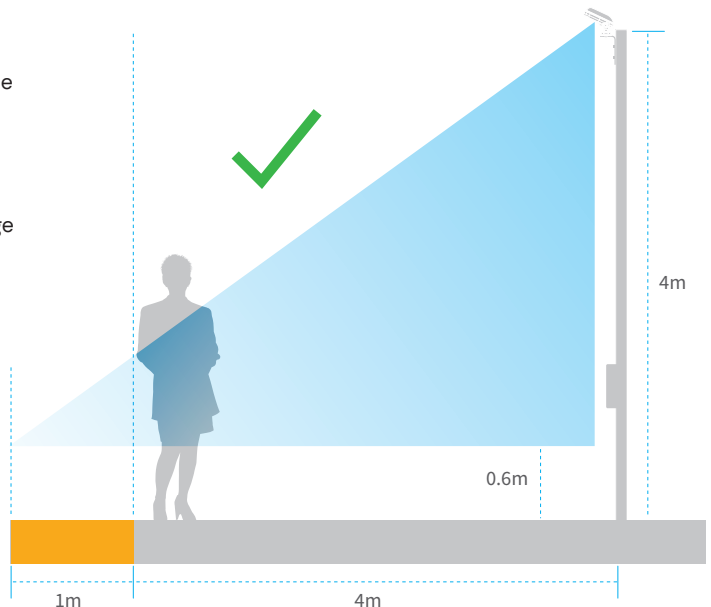

STEP 3 – CALIBRATE

The third and final stage in the set-up is 'Calibration'. Check the selected zone-area, ensure the zone is empty, then click 'On-Site Calibration'.

Successful completion of the calibration will result in the detector returning to the 'Home' page.

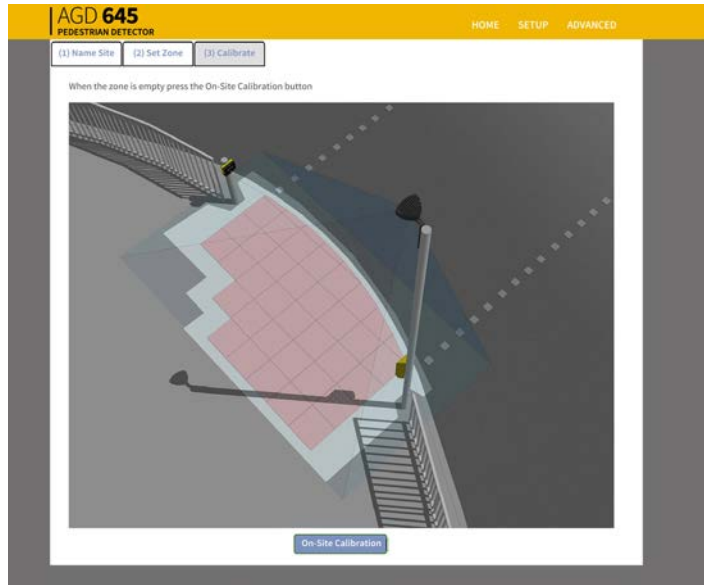

HOME PAGE

Following successful calibration you will view your selected zone actively 'detecting' on the 'Home Page' – and helpfully, if the detector has been previously setup you will come straight to the Home Page on connection.

The image you see on the screen will be the detect area with any area excluded greyed out.

Monitor the zone and check the detector triggers – the front LED will illuminate and extinguish when someone enters and leaves the zone.



HOME PAGE

An example of what you will see once step 1, 2 and 3 has been completed correctly.

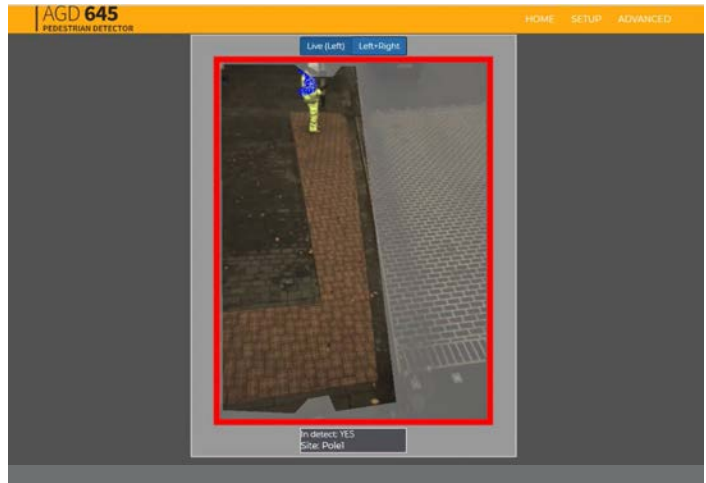

OPTIONAL PARAMETERS

Static IP

See Technical Resource section for more information

Occupancy

See Technical Resource section for more information

Wifi off after 24 hours

Select this box to disable the WiFi after 24 hours. The device will need to be power cycled to have the WiFi network viewable after this period.

Detect LED on at night

Select this to allow the detector to illuminate the front RED led at night.

Hold Time (sec)

This value denotes the amount of time the detection OPTO output is held **AFTER** a valid target leaves the area of detection. **Input range** = 0 - 60 seconds. **Default** = 2 seconds

User notes

An editable field to allow engineers to store notes in the device. **Max characters** = 64 bytes

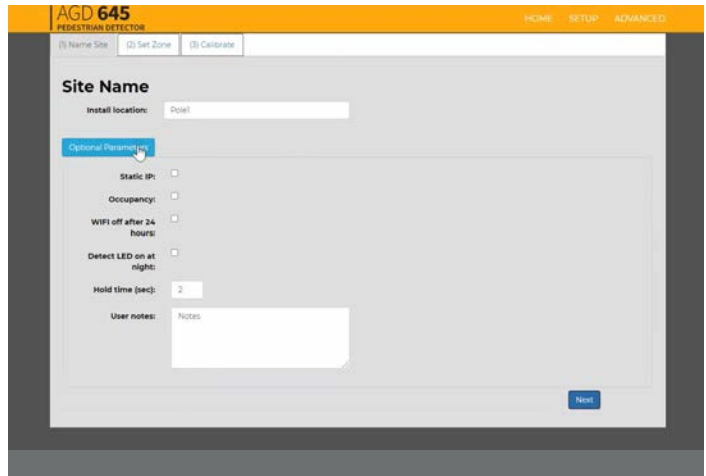

Conversion Table

1m = 3.3ft		1ft = 0.3m	
Popular Mounting Heights		Popular Range Measurements	
m = ft		m = ft	
2.0	= 6.6	5	= 16.5
2.5	= 8.3	10	= 33.0
3.0	= 9.9	15	= 49.5
3.5	= 11.6	20	= 66.0
4.0	= 13.2	25	= 82.5
4.5	= 14.9	50	= 165.0
5.0	= 16.5	100	= 330.0
5.5	= 18.2	150	= 495.0
6.0	= 19.8	180	= 594.0

Please Note: The table above is a generic meters to feet conversion table to aid international customers.

For product specific mounting heights and detection ranges, please refer to the relevant sections of this product manual.

PHYSICAL INSTALLATION

TYPICAL INSTALLATION PARAMETERS

As described previously, the AGD645 operates with a high degree of accuracy when mounted inside normal parameters. The diagram below shows a plan view of the expected coverage of the stereo cameras when the device is mounted at a height between 3.5–4.0 metres.

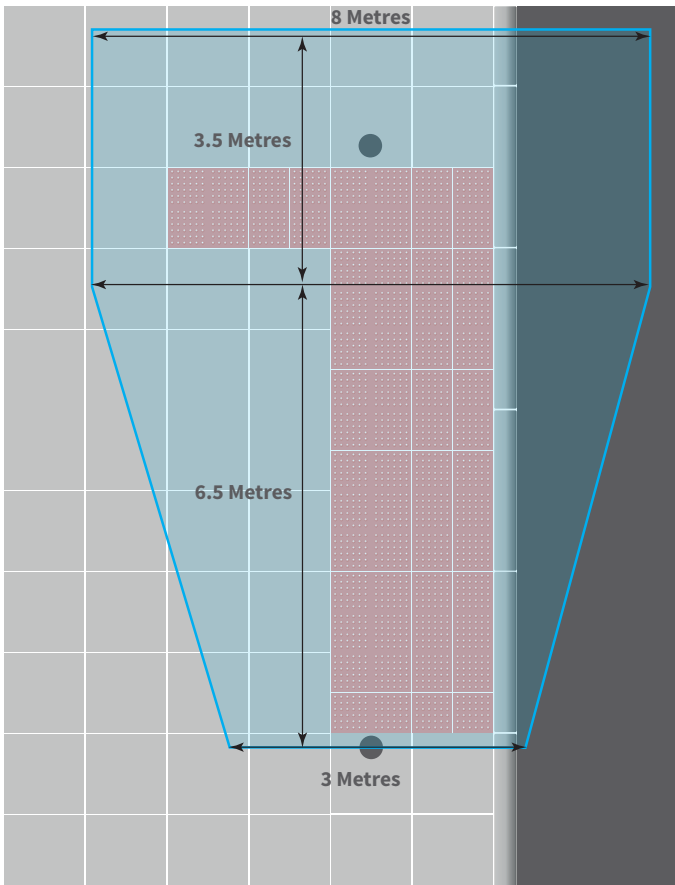

10m x 3m Zone - Illustrated using nominal mounting height of 3.5-4.0m

ELECTRICAL INSTALLATION

ETHERNET INTERFACE

The AGD645 has a Cat 6 Ethernet Interface provided on the product connector on the rear of the unit. The 645 can be connected to a network and obtain an IP address through a DHCP server. Alternatively, the IP address, gateway and netmask may be set to customer specified values.

MATING CONNECTOR DETAILS

Product mating connector: Binder O9-3782-91-08



FIELD INSTALLABLE CONNECTOR

Cable mount connector: Binder 99-3787-810-08

Connector is wired as per the manufacturers instructions



P.O.E - POWER OVER ETHERNET REQUIREMENTS

AGD645 P.O.E REQUIREMENTS

Type 1 Class 3 Device

802.3at Compliant and Isolated

6.49W to 13W (7W nominal)

37.0v to 57.0v

Supports Mode A and Mode B Wiring

ELECTRICAL INSTALLATION

CONNECTING ETHERNET

There are multiple ways to wire and connect the ethernet of the AGD645 to a roadside network. AGD suggest using one of the two methods pictured below:



OPTION 1

An SWA (steel wire armoured) CAT 5E/6 cable is installed between the traffic cabinet and the signal pole where the AGD645 is to be mounted.

The field installable connector is then fitted directly to the cable and plugs into the rear of the detector.

The part number for the cable mount connector is:

Binder 99-3787-810-08

OPTION 2

An SWA (steel wire armoured) CAT 5E/6 cable is installed between the traffic cabinet and the signal pole where the AGD645 is to be mounted.

This cable end is then terminated with a regular RJ45 crimp end. As per the diagram, this is simply clicked into an inline coupler and then into a 1m pre-assembled cable.

This is the preferred method as it allows the use of standard tooling and allows testing and fault finding to be carried out in an easy manner using regular RJ45 network test equipment.

The part number for the pre-assembled cable is:

Metz Connect - 142M2X15010

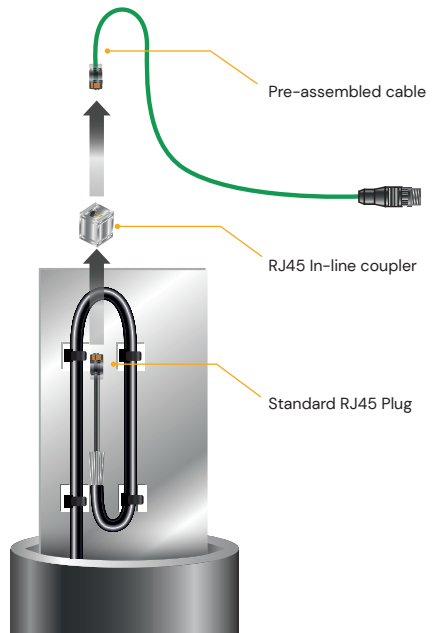

CONNECTING / COMMISSIONING

ETHERNET SETTINGS

The AGD645 can be connected to a network and obtain an IP address through a DHCP server. Alternatively, the IP address, gateway and netmask may be set to customer specified values.

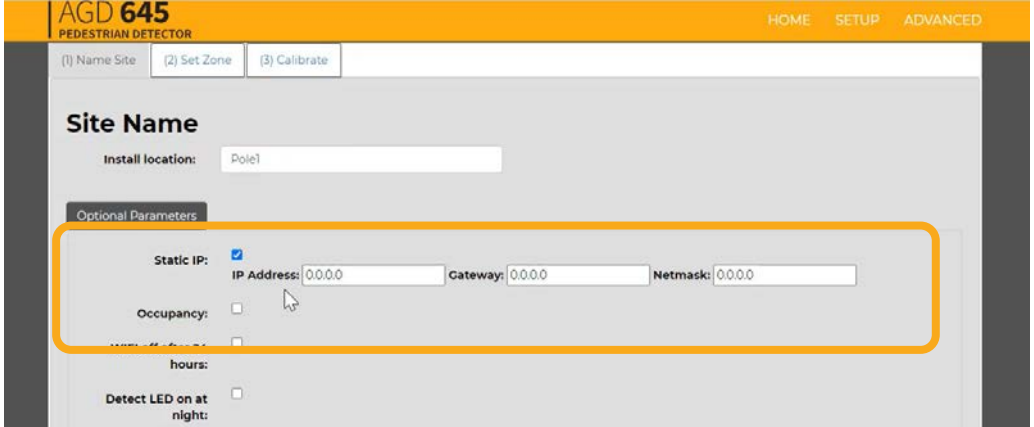

The ethernet settings can be accessed under the 'optional parameters' in stage one of the setup process. When using static IP settings, please consult your networking professional for assistance.

CONNECTING / COMMISSIONING

OCCUPANCY SETTINGS

Use of the AGD645 occupancy mode allows the invitation time when crossing the road to be dynamically adjusted dependent upon the volume of people waiting to cross. This is ideal for sites that have a different influx of people using the crossing on an irregular basis such as, Schools, event venues and areas where large number of pedestrians can become trapped upon a central reservation.

This selectable function is available on all AGD645 kerbside detectors from September 2018 and is easily accessible via the set-up menu.

The 'Occupancy' setting can be accessed and turned on under the 'optional parameters' menu in stage one of the setup process.

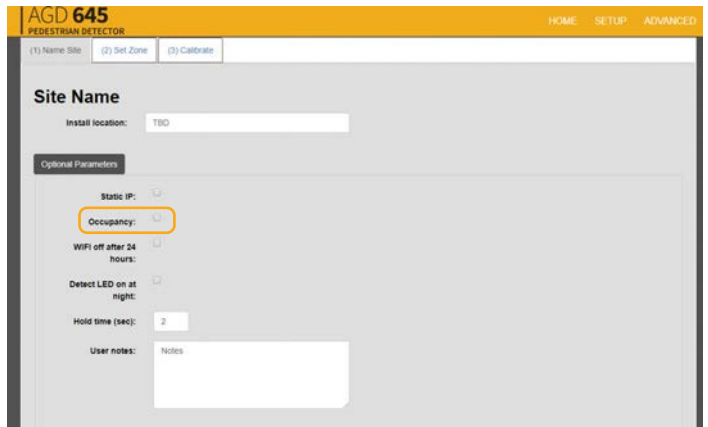

Once turned on, the occupancy reveals a slider bar. The three coloured components represent the percentage value for the state of occupancy. Here, the values represented are:

- Low = <15%
- Medium = 15-85%
- High = >85%

***The lowest the bottom slider may be set is 10%.**

***The highest the bottom slider may be set is 90%.**

***The gap between low and high must be >15%.**

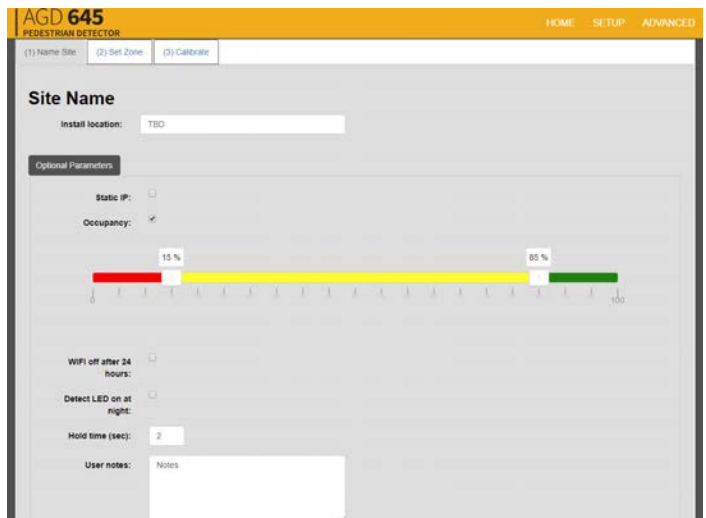

CONNECTING / COMMISSIONING

OCCUPANCY SETTINGS

It's important to note the percentage value set represents the entire 645 field of view not just the zone of interest marked by the masked area. If the zone of interest is small compared to the field of view then the slider bars need to be set low to account for this. If the zone of interest is set too small then it may be difficult to differentiate between LOW, MEDIUM and HIGH outputs.



The zone of interest is depicted by the area inside of the grey mask. This image shows the detector having a **'LOW'** occupancy.



The zone of interest is depicted by the area inside of the grey mask. This image shows the detector having a **'MEDIUM'** occupancy.

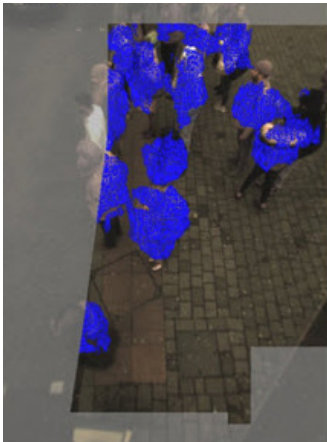

The zone of interest is depicted by the area inside of the grey mask. This image shows the detector having a **'HIGH'** occupancy.

The state of the OPTO outputs in relation to the occupancy is shown in the table below:

Occupancy	Opto 1	Opto 2
No-Detect	OFF	OFF
Low	OFF	ON
Medium	ON	OFF
High	ON	ON

PHYSICAL INSTALLATION

If the unit is not operating correctly, please check the following, has the unit been:

- 1) Mounted within the recommended height of 3–6 metres?
- 2) Angled according to the installation guide to provide good coverage of the detection area?
- 3) Installed with any obstructions in the viewable area such as the traffic signal head?

ELECTRICAL INSTALLATION

If the unit is not operating correctly, please check the following:

- 1) Is power present at the unit?
- 2) Is the red LED illuminated when power is applied to the unit?
- 3) Is there sufficient current to run the unit – identified by the red LED failing to flash or flashing only once during power-up and the web page not starting correctly? Refer to technical specification table.

CONNECTING / COMMISSIONING

If the unit is not operating in the prescribed manner, please check the following:

- 1) Is the LED on the front of the unit you wish to connect to illuminated blue to show that the WiFi network is successfully connected?
- 2) Has the correct IP Address been entered into the browser address bar?
- 3) Have you followed the AGD Touch–setup stages correctly and verified correct operation?

If trouble with any operations persist, please contact AGD Technical Support.

AGD TECHNICAL SUPPORT

Email: technical@agd-systems.com

Tel: +44-1452-557404

TECHNICAL SPECIFICATIONS

AGD645

Pedestrian Detector

PRODUCT DIMENSIONS

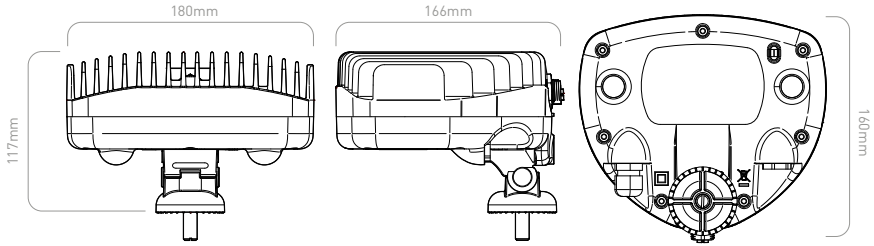

SPECIFICATIONS

Description	Pedestrian Detector
Technology	AGD 3D HD Optical Stereo Vision
Detection Zone	10m x 3m (Polygonal Mask Set-up)
Mounting Height	3–6m (3.5m nominal)
Power Supply	24V AC/DC
Power	8.0W @ 24V AC/DC (330mA)
WiFi Frequency/Power	Frequency range (MHz): 2412–2472 Highest EIRP power in the range (dBm): 19.7
Detect Output	Single Opto / IP Ready
LED Indication	Front LEDs for detect and WiFi connection
Real-time Video	Yes
Housing Material	Black Polycarbonate / Aluminium
Sealing	IP65 & NEMA 250 4X
Operating Temp	–34°C to +74°C
Configuration	WiFi AGD Touch-Setup
Lux Level	Below 15 lux an infrared illuminator is recommended
Dimensions	W 181mm x D 160mm x H 117mm
Weight	1400g
Complies with	EMC: BS EN 50293:2012, EN 301 489–17, EN 301 489–1 Health & Safety: BS EN 62368, EN 60950–22, EN 62311 Spectrum: EN 300 328 RoHS: EN 50581 Other: TOPAS 2507A, NEMA TS 2 2016
Patent No.	GB 2448617

*For US special build variant required

Owing to the Company's policy of continuous improvement, AGD Systems Limited reserves the right to change their specification or design without notice.



Restriction on Hazardous Substances



Registration Evaluation Authorisation and Restriction of Chemicals

END OF LIFE

AGD645

Pedestrian Detector

DISPOSAL INSTRUCTIONS (EOL)

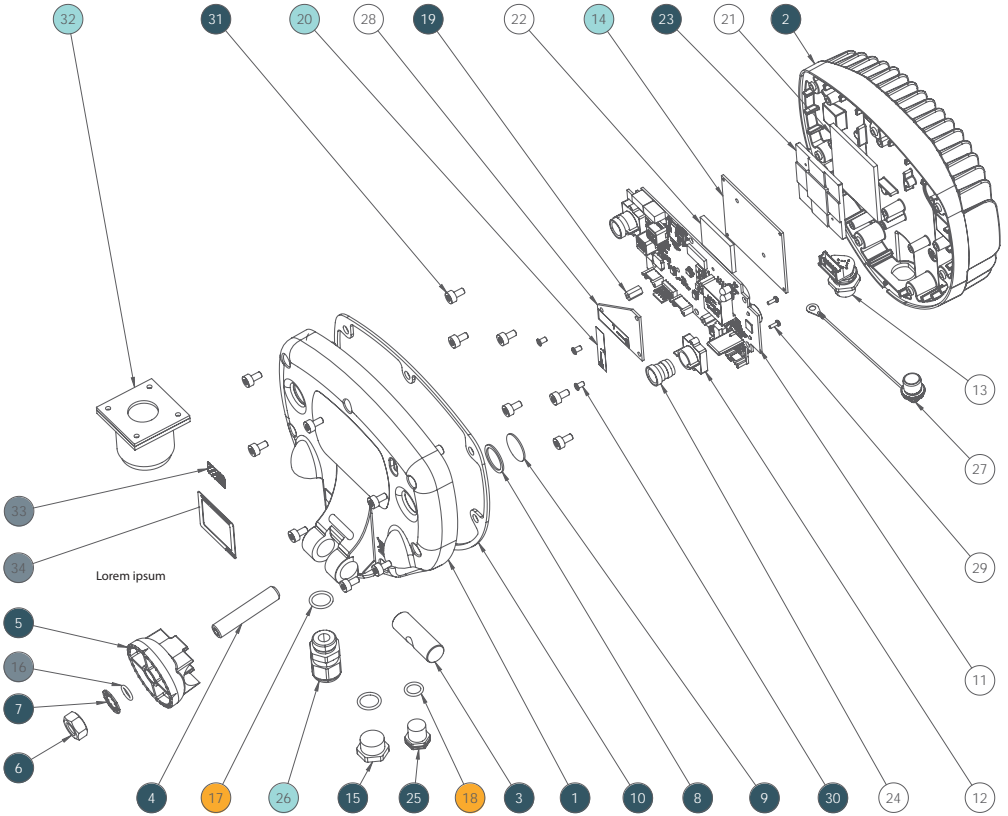

Item	Qty	Material
1	1	Polycarbonate
2	1	Powder Coated Aluminium
3	1	Aluminium
4	1	Stainless Steel
5	1	Polycarbonate
6	1	Stainless Steel
7	1	Stainless Steel
8	2	Polyethylene
9	2	Glass
10	1	Neoprene
11	1	Printed Circuit board
12	2	ABS

Item	Qty	Material
13	1	Printed Circuit board Ass.
14	1	Printed Circuit board
15	1	Nylon
16	1	Nitrile
17	2	EPDM
18	1	EPDM
19	3	Nylon
20	2	Printed Circuitboard
21	1	Soft therm
22	1	Ceramic Powder Filled Silicon Resin

Item	Qty	Material
23	1	Copper
24	2	Mixed Metal & Glass
25	1	Nylon
26	1	Mixed Metal & PVC
27	1	Mixed metal
28	1	FR4
29	4	Stainless Steel
30	3	Steel
31	13	Stainless Steel
32	1	Mixed Metals, Nylon & PVC
33	1	Polyester
34	1	Polyester

- Reuse / Recycle
- Separate & Recycle
- Downcycle
- Hazardous Recovery
- Non-Recyclable

IMPORTANT

AGD645

Pedestrian Detector

SAFETY PRECAUTIONS

All work must be performed in accordance with company working practices, in-line with adequate risk assessments. Only skilled and instructed persons should carry out work with the product. Experience and safety procedures in the following areas may be relevant:

- **Working with mains power**
 - **Working with modern electronic/electrical equipment**
 - **Working at height**
 - **Working at the roadside or highways**
1. This product is compliant to the Restriction of Hazardous Substances (RoHS – European Union directive 2011/65/EU).
 2. The product must be correctly connected to the specified power supply. All connections must be made whilst the power supply is off or suitably isolated. Safety must always take precedence and power must only be applied when deemed safe to do so.
 3. No user-maintainable parts are contained within the product. Removing or opening the outer casing is deemed dangerous and will void all warranties.
 4. Under no circumstances should a product suspected of damage be powered on. Internal damage may be suggested by unusual behaviour, an unusual odour or damage to the outer casing. Please contact AGD for further advice.
 5. This Product is Compliant with the European Radio Equipment Directive 2014/53/EU. There are no restrictions of use within any EU Member state for this product. This product is Receiver Category 2.



DISCLAIMER

While we (AGD Systems) endeavour to keep the information in this manual correct at the time of download or print, we make no representations or warranties of any kind, express or implied, about the completeness, accuracy, reliability, suitability or availability with respect to the information, products, services, or related graphics contained herein for any purpose.

Any reliance you place on such information is therefore strictly at your own risk. In no event will we be liable for any loss or damage including without limitation, indirect or consequential loss or damage, or any loss or damage whatsoever arising from loss of data or profits arising out of, or in connection with, the use of this manual.

Warranty

All AGD products are covered by a 12 month return to factory warranty. Products falling outside this period may be returned to AGD Systems for: evaluation, repair, update or re-calibration, any of which may be chargeable.

Revision
Issue 6 April 2021



AGD[®] | SAFER
GREENER
MORE EFFICIENT

AGD Systems Limited

White Lion House, Gloucester Road,
Cheltenham, GL51 0TF, UK

Tel: +44 (0) 1452 854212

Email: info@agd-systems.com

Web: agd-systems.com