



AGD650

AI Multi Modal Detector

The AGD650 AI Multi Modal detector is a smart, optical, dynamic environment detector that makes intersections and junctions more efficient by delivering robust vehicle detection data at the stop-line of multi lane approaches.

The AGD650 has inbuilt artificial intelligence and makes use of a new neural processing platform and sophisticated algorithms to provide ultra-reliable real-time detection and automated decision making on vehicle types, including bicycles and scooters

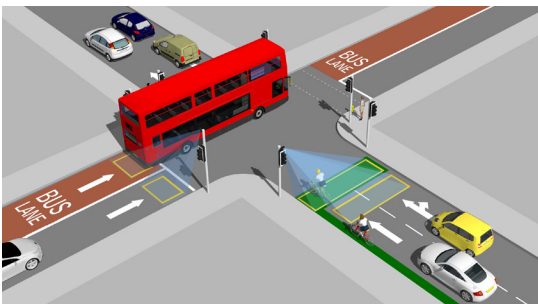
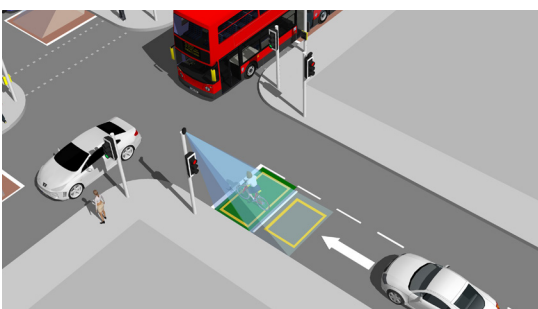
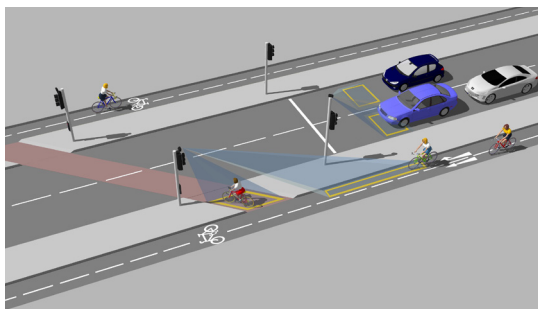
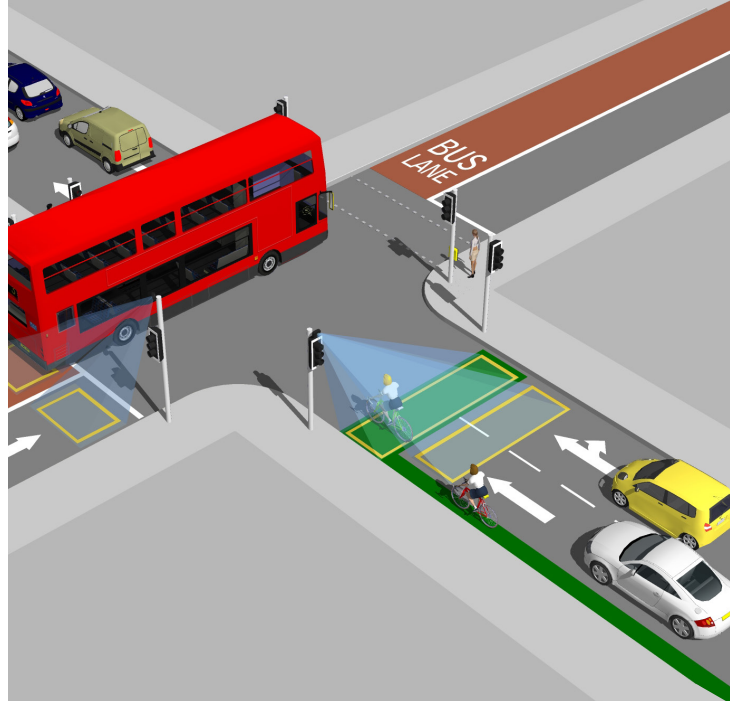

KEY FEATURES

- Detection of moving & stationary targets at the stop-line
- Two independent user adjustable detection zones
- Deep learning image recognition allows for prioritisation of vehicle types
- In-built AI aids target differentiation
- WiFi AGD Touch-setup - speeds up installation & reduces risk

AGD650

AI Multi Modal Detector



With in-built artificial intelligence (AI) it is a high performance product that processes information on board with a new neural processing platform and sophisticated algorithms for automated decision-making to provide ultra-reliable detection.

The AGD650 employs high grade optics and deep learning image recognition to detect stationary and moving targets as they approach the stop-line. The neural net has undergone extensive training to develop a library of vehicle types. Objects that are not defined within this library are simply ignored.



DIRECT COMMUNICATIONS WITH ITS CONTROL ROOMS

This exciting platform will have future capability to support the needs of smart cities by exporting detailed information about target types. The IP, POE, real-time video, capabilities will be accessed 'down the wire' straight into ITS control rooms – empowering truly informed decision making.

High percentage confidence of target type

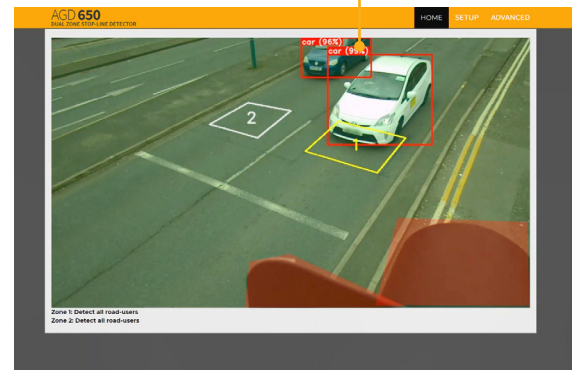

Intelligent capture of non 4 wheeled vehicles

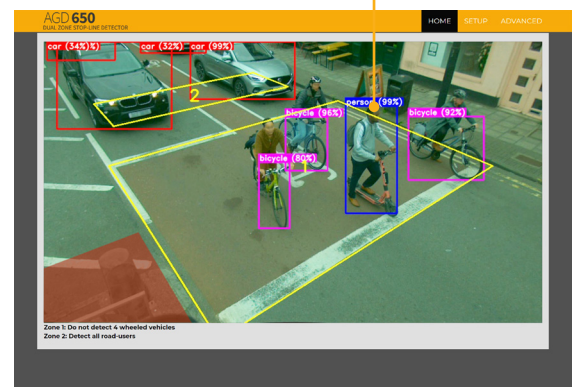

AGD TOUCH

WiFi 3 Click Setup

WIFI AGD TOUCH-SETUP

The AGD650 is quick to setup using any WiFi device – smart-phone, tablet or laptop – with its unique & secure AGD Touch-setup that allows installers to configure the device in three simple steps:

1. Name device
2. Select and set virtual loops
3. Save settings

Multiple AGD detectors may be setup at the same time from a safe position on the ground, or in a vehicle up to 30m away. Conveniently, the AGD650 can be adjusted for zone changes just as quickly in the same way.

1

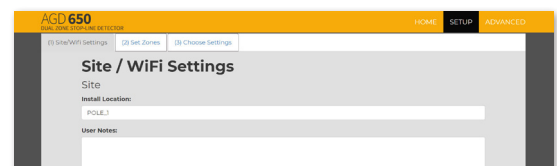

2

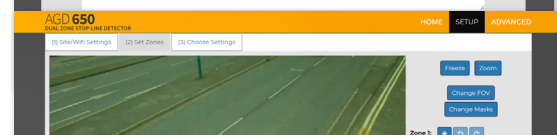

3

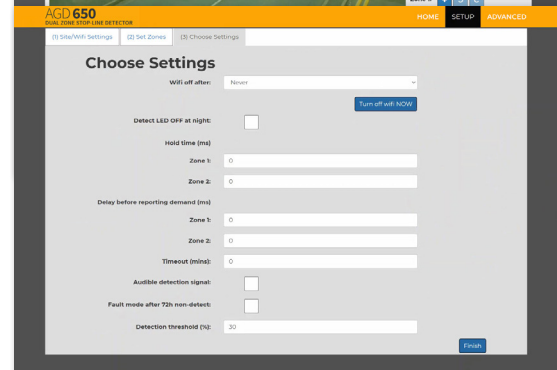

AGD650

AI Multi Modal Detector

PRODUCT SPECIFICATION

Description	AI Multi Modal Detector
Technology	AGD Optical Vision with AI
Detection Zone	Dual Virtual Loops
Mounting Height	3-6m Nominal
Power Supply	24V ac/dc, 42V ac
Typical power at 20°C	2024 onwards (\geq MI-220-8): 10.5W @ 24V ac; pre-2024 (\leq MI-220-7): 12W @ 24V ac.
WiFi Frequency/Power	2412-2472 MHz / Highest EIRP power in the range (dBm): 19.7'
LED Indication	LEDs for detect and WiFi connection
Frames per second	6.7
Housing Material	Black Polycarbonate / Aluminium
Range	20m at full FOV / 30m at reduced FOV
Ingress Protection	IP66
Operating Temp	-34°C to +74°C
Configuration	WiFi AGD Touch-Setup
Lux Level	Operates down to 20 Lux
Dimensions	W 217mm x D 94mm x H 175mm
Weight	1200g
Complies with	EMC (Art 3.1(b)): EN50293:2012 EN301 489-17 V3.2.4 EN301 489-1 V2.2.3 Health & Safety (Art 3.1(a)): EN IEC 62368-1:2020+A11:2020 EN 50556:2011 EN 62479:2010 Spectrum (Art 3.2): EN 300 328 V2.2.2 ROHS: EN IEC 63000:2018 Other: TOPAS 2505B Appendix E
Patent No.	Patent Pending - GB2619098

TESTED AND AGD CERTIFIED

All AGD products are Tested, Calibrated and AGD Certified so customers know that all devices will perform exactly as described.

AGD[®] | SAFER
GREENER
MORE EFFICIENT

AGD Systems Limited
White Lion House, Gloucester Road
Cheltenham, GL51 0TF, UK

Tel: +44 (0) 1452 854212

Email: info@agd-systems.com

Web: agd-systems.com

DIMENSIONS

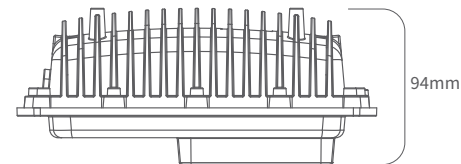
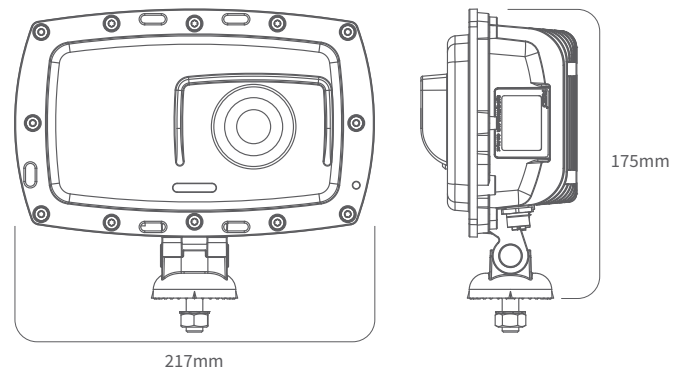

The smart optical AGD650 with AI and target recognition provides even greater performance at the Stop-line than its predecessor the AGD316 radar used on thousands of sites worldwide. The future IP capable AGD650 is the ideal detection solution for multi lane intersection approaches in smart city environments.