

AGD® | SAFER
GREENER
MORE EFFICIENT



PRODUCT MANUAL

AGD650

AI Multi Modal Detector

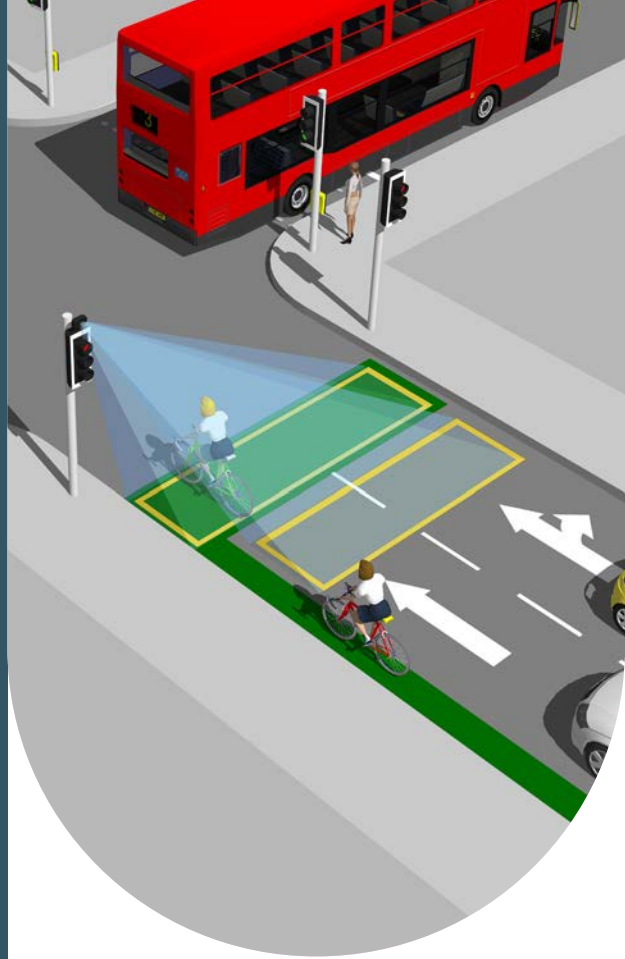

AGD-SYSTEMS.COM

TABLE OF CONTENTS

AGD650

AI Multi Modal Detector

INTRODUCTION	3	ENABLING BUS-ONLY DETECTION	16
Product Overview and technology	3	TROUBLESHOOTING	21
Key features	3	Physical installation	21
Typical applications	3	Electrical installation	21
Product overview image	4	Connecting / Commissioning	21
Product Variants	4	TECHNICAL SPECIFICATIONS	22
INSTALLATION AND COMMISSIONING	5	Product Specification	22
Physical Installation	5	END OF LIFE DOCUMENT	23
Step 1 – Mounting height	6	IMPORTANT SAFETY INFORMATION	24
Step 2 – Detector alignment	6	Safety precautions	24
Step 3 – Final adjustment & verification	6	DISCLAIMER	26
Electrical Installation	7	Warranty	26
Connections	7	Contact Details	26
Power Up Sequence	8		
Connecting	8		
Connecting Wifi	8		
Connecting device	8		
Set-up device using Wifi AGD Touch-setup	9		
Step 1 – Name site	9		
Step 2 – Set zones	10 – 12		
Change masks	11		
Detection zones	12		
Step 3 – Choose settings	13		
Example image 1	14		
Example image 2	15		



AGD TOUCH

WiFi 3-Click Setup

INTRODUCTION

AGD650

AI Multi Modal Detector

PRODUCT OVERVIEW AND TECHNOLOGY

The AGD650 AI Multi Modal detector is a smart optical detector designed for use in dynamic environments. It makes intersections and junctions more efficient by delivering robust vehicle detection data at the stop-line of multi lane approaches.



With in-built artificial intelligence (AI) it is a high performance stand-alone product that processes information on board with a new neural processing platform and sophisticated algorithms for automated decision-making to provide ultra-reliable detection.

The AGD650 employs high grade optics and deep learning image recognition to detect stationary and moving targets as they approach the stop-line. The neural net has undergone extensive training to develop a library of vehicle types. Objects that are not defined within this library are simply ignored.

TYPICAL APPLICATIONS



Dual Zone / Active Travel (Cycle Lane Detection)



Dual Zone / Multi lane Advance Stop-line (cycle refuge area)

KEY FEATURES

- Detection of moving & stationary targets at the stop-line
- Two independent user adjustable detection zones
- Deep learning image recognition allows for prioritisation of vehicle types
- In-built AI aids target differentiation
- WiFi AGD Touch-setup – speeds installation & reduces risk

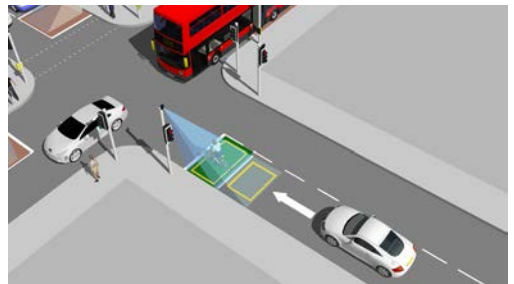

Single lane Advance Stop-line (cycle refuge area)

INTRODUCTION

AGD650

AI Multi Modal Detector

PRODUCT OVERVIEW IMAGE



PRODUCT VARIANTS

650-400-022	AI Multi Modal Detector/24-42V/Dual Opto Output/1m + mating lead
650-401-022	AI Multi Modal Detector/24-42V/Dual Opto Output/5m flying lead
650-402-022	AI Multi Modal Detector/24-42V/Dual Opto Output/5m flying lead/NEMA

PHYSICAL INSTALLATION - PARAMETERS

AGD650

AI Multi Modal Detector

PHYSICAL INSTALLATION

The AGD650 requires specific installation parameters to allow the detector to operate correctly. Installing it outside of these basic design parameters can reduce performance and detection accuracy so it's important to ensure you are within these parameters when installing the detector.

DISTANCE FROM MOUNTING POLE TO NUMBER OF LANES COVERED

The pole's location can restrict the number of lanes the AGD650 can be deployed on due to the detector's field of view.

Minimum pole distance from stop-line (m)	Number of lanes covered (3.4m lanes)
1.2	1
1.8	2
2.4	3
3.0	4

Choosing the correct mounting pole on different junctions

It's important to mount the detector on the recommended pole to ensure high performance and reduce occlusion.



Mount on the side of the road with the lowest number of large vehicles (bus lanes/HGV routes)



Mount on the side of the road closest to approaching cyclists for cycle refuge applications

Mounting position in different environments

When installing the AGD650 on the traffic head, please use the 6" extension bracket supplied to allow it to see over the backing boards and detect traffic at the stop-line. If the stop-line is 1.4m or less from the mounting pole, then a 90° bracket looking around the traffic head is recommended.



1.4m or closer



Greater than 1.4m

INSTALLATION AND COMMISSIONING

PHYSICAL INSTALLATION STEP 1 – MOUNTING HEIGHT

The AGD650 AI Multi Modal Detector has excellent performance when mounted between heights of 3–6 metres.

If you have an application whereby you wish to mount the detector outside of these heights, then please contact AGD.

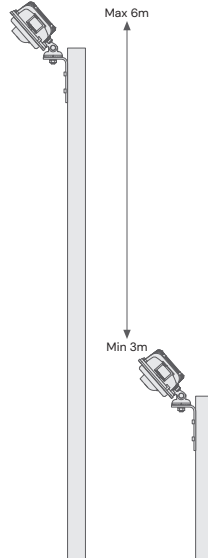

AGD650

AI Multi Modal Detector

STEP 2 – DETECTOR ALIGNMENT

The AGD650 AI Multi Modal Detector should be mounted using the supplied hardware. The optimal mounting angle will change depending on the installation location; aiming the camera to the centre of the area of interest is a good start position. The mounting angle may need to be corrected during commissioning stage of the installation. Ensure the detector is securely fixed and the mounting nut is tight.

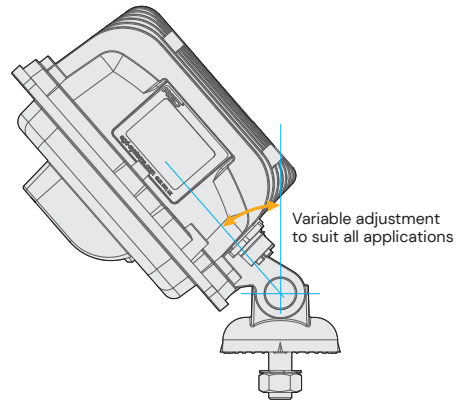

STEP 3 – FINAL ADJUSTMENT & VERIFICATION

Confirm the detector is correctly aligned. The entire stop-line should be visible when looking at the detector's live view within the GUI. Where possible, the field of view should include at least one full vehicle length before and after each detection zone. The horizon should be out of view to reduce sun glare. Once complete, please monitor traffic to ensure zones are correctly placed.



ELECTRICAL INSTALLATION

The detector is powered using a 24V ac/dc, 42V ac ($\pm 20\%$) supply. The power is applied to the detector using the multi-pin mating connector. The AGD650 Zone Stop-line Detector is provided with a Buccaneer Series PX0728/S 9 pole connector or flying leads to enable direct connection to any traffic control system.

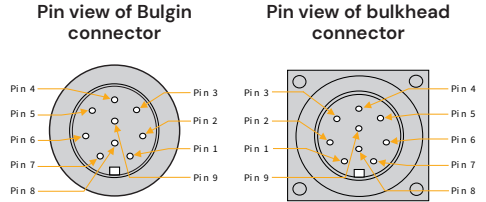

Single Cable 24V ac/dc, 42V ac Supply Wiring (1m bulkhead lead with Bulgin connector)

Pin No.	Wire Colour	Function	Power Off	Power On-No Detect	Power On-Detect	Notes
1	Red	24V ac/dc, 42V ac	-	-	-	-
2	Black	0V ac/dc	-	-	-	-
3	Green	Earth/Ground	-	-	-	Must be connected
4	White	Opto 1/2 Common	-	-	-	-
5	Yellow	Opto 1 N/O	N/O	N/C	N/O	Zone 1
6	Blue	Opto 1 N/C	N/C	N/O	N/C	Zone 1
7	-	Not Connected	-	-	-	-
8	Brown	Opto 2 N/O	N/O	N/C	N/O	Zone 2
9	Violet	Opto 2 N/C	N/C	N/O	N/C	Zone 2

Single Cable 24V ac/dc, 42V ac Supply Wiring (5m flying lead)

Wire Colour	Function	Power Off	Power On-No Detect	Power On-Detect	Notes
Red	+24V ac/dc, 42V ac	-	-	-	-
Grey	0V ac/dc	-	-	-	-
Green	Earth/Ground	-	-	-	Must be connected
White	Opto 1/2 Common	-	-	-	-
Yellow	Opto 1 N/O	N/O	N/C	N/O	Zone 1
Blue	Opto 1 N/C	N/C	N/O	N/C	Zone 1
-	Not Connected	-	-	-	-
Brown	Opto 2 N/O	N/O	N/C	N/O	Zone 2
Pink	Opto 2 N/C	N/C	N/O	N/C	Zone 2

Opto-coupler ratings

- Max current 60mA
- Max Voltage 60V
- Max on-state impedance 25 Ohms

The voltage tolerances of supply

- 24V ac/dc, 42V ac $\pm 20\%$

POWER UP SEQUENCE

After applying power to the unit, the red LED will illuminate for approx 30s while the operating system loads. The red LED will then flash 5 times. If no detection zones have been set, the LED will remain on. When at least one detection zone has been set, the red LED will come on when either zone is in the detect state and will turn off if neither zone is in detect.

Upon power up, owing to the nature of the equipment power supply, an initial current of 15A <5ms can be drawn. The supply should be fused as follows: 24V ac/dc, 42V ac – 3A circuit breaker or in-line fuse.

The table below shows typical currents (amps) at various different voltages and operating temperatures.

	Temperature (°C)	-25	+20	+60	+74
Voltage	24 Vdc	0.405	0.405	0.460	0.518
	24 Vac	0.535	0.535	0.605	0.662
	42 Vac	0.350	0.350	0.390	0.425

CONNECTING

The AGD650 AI Multi Modal Detector has been designed with efficiency and ease of use in mind. It can be set up simply by connecting to it by WiFi and using a browser window. No additional software needs to be installed.

This step-through process describes the actions required to set up the detector upon initial deployment when first removed from the box.

CONNECTING WIFI

Check the red LED has illuminated and flashed 5 times on the rear of the unit. Search for the unit and identify it by its **serial number (S/N)**:

650:XXXXXX-XXXX-TBD (the 'X's denote the S/N, TBD is a renamable field used to name the pole location the 650 is installed on)

Click 'connect' and input the **default password**:

Agd650:XXXXXX-XXXX (the 'X's denote the S/N)

For security reasons, AGD Systems strongly recommends changing the password during step 1 of the set-up process.

Please note that, if the password is changed and the new password is lost, the product will need to be returned to AGD to be reset.

The LED on the underside of the unit should now be illuminated blue to show WiFi is successfully connected and your device should show connected.

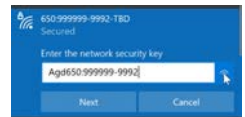

CONNECTING DEVICE

Complete Wifi connection step as above.

Launch a browser on your smartphone, tablet or laptop (Modern versions of Google Chrome, Safari, Firefox and Microsoft Edge are all supported).

In the address bar of your browser, enter the 'IP Address':

http://10.42.0.1:8080

You will be presented with your initial AGD Touch-setup page.

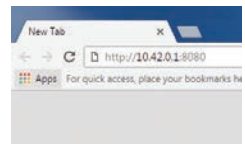

SET-UP DEVICE USING AGD TOUCH-SETUP

When logged in to the device for the first time you are presented with the set-up screen. This is the AGD Touch-Setup, a three stage process that

allows installers to configure the device quickly and efficiently.

STEP 1 – NAME SITE

The screenshot shows the AGD 650 Dual Zone Stop-Line Detector setup interface. At the top, there is a navigation bar with 'HOME', 'SETUP', and 'ADVANCED' tabs. Below this, a progress indicator shows three steps: '(1) Site/WiFi Settings', '(2) Set Zones', and '(3) Choose Settings'. The main content area is titled 'Site / WiFi Settings' and is divided into two sections: 'Site' and 'WiFi'. In the 'Site' section, there is a field for 'Install Location' containing 'POLE_1' and a larger 'User Notes' text area. The 'WiFi' section includes a field for 'SSID Prefix' with the value '650-999999-0009' and an 'Allow changes' checkbox. Below this, the 'Effective SSID' is displayed as '650-999999-0009-POLE_1'. A red warning message states: 'For security reasons, it is strongly recommended that the password is changed during initial setup.' There are two password fields: 'New password' and 'Confirm password', both with eye icons for visibility. A 'Please Note' section at the bottom explains that if the password is changed and lost, the device will need to be reset. A blue 'Next' button is located at the bottom right of the form.

Install location – Used to locate the detector when installed on a site. Entering an install location changes the detector’s SSID.

You must reconnect to the new SSID after a change is made.

E.g. Inserting POLE_1 will change the SSID WiFi name to 650:999999-9992-POLE_1

The use of a “space” within this field is not supported; use an underscore “_” in its place.

Please note: If you have entered characters in this field, you will be notified and have to reconnect to the new SSID after clicking “next”

User notes – An editable field to allow engineers to store notes in the device. Max characters = 110.

SSID prefix – The first part of the SSID can be changed. To change, you must first tick allow changes. Default is recommended if using the default password.

Please note: If you have changed characters in this field, you will be notified and have to reconnect to the new SSID after clicking “next”

Effective SSID – Displays what SSID will be shown when searching for the new WiFi connection.

New password/Confirm password – To keep the default password, leave these fields blank. To change you must enter an identical password in both fields. Characters = 8 minimum, 63 maximum.

SET-UP DEVICE USING AGD TOUCH-SETUP

Step 2 – Set Zones

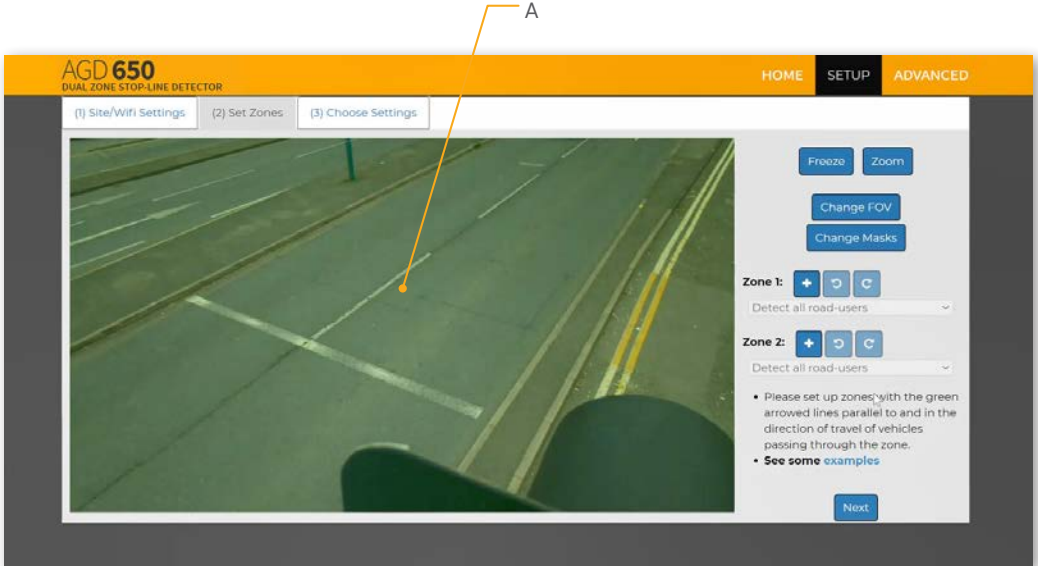

A – Live Traffic View

Freeze – Pause the live traffic view when the road is clear of traffic to aid set-up.

Zoom – Zoom out to extend zones off the screen.

Change FOV – Full field of view is recommended for most installations. A reduced field of view may be beneficial when detection zones are distant from the detector. Please contact AGD for advice.

Change Masks – Used to mask objects to avoid unwanted detections. See STEP 2 – SET ZONES CONTINUED section for further detail.

Zone 1 – Detection area linked to OPTO 1 output.

Add / Undo / Redo buttons for quick set-up.

Zone 2 – Detection area linked to OPTO 2 output.

Add / Undo / Redo buttons for quick set-up.

Detection Classes

Detect all road users: Detect all forms of vehicle and pedestrians.

Detect 4 wheeled vehicles only: Detect all types of vehicles with 4 wheels or more ignoring all motorbikes, cyclists, scooters and pedestrians.

Do not detect 4 wheeled vehicles: Only detect motorbikes, cyclists, e-scooters and pedestrians. Ignore all other vehicle types.

Custom: Select from available classification filter options, eg: buses

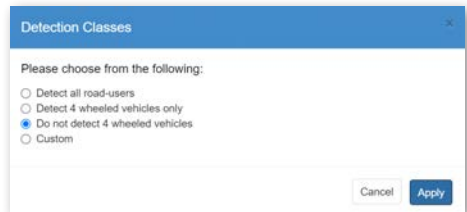

SET-UP DEVICE USING AGD TOUCH-SETUP

Step 2 – Set Zones continued

Change Masks

Occasionally, street furniture within the image can give rise to false detections. This can be resolved through the application of a mask. A mask is a region of the image within which the detector will not report targets. **Masks should be used sparingly.** It can be prudent to mask any foreground street furniture such as a close-up

view of the back of a signal head. Use of masks in other areas can sometimes be beneficial for resolving specific issues but should not be routinely employed. It is important to note that vehicles moving through a masked region might not be detected.

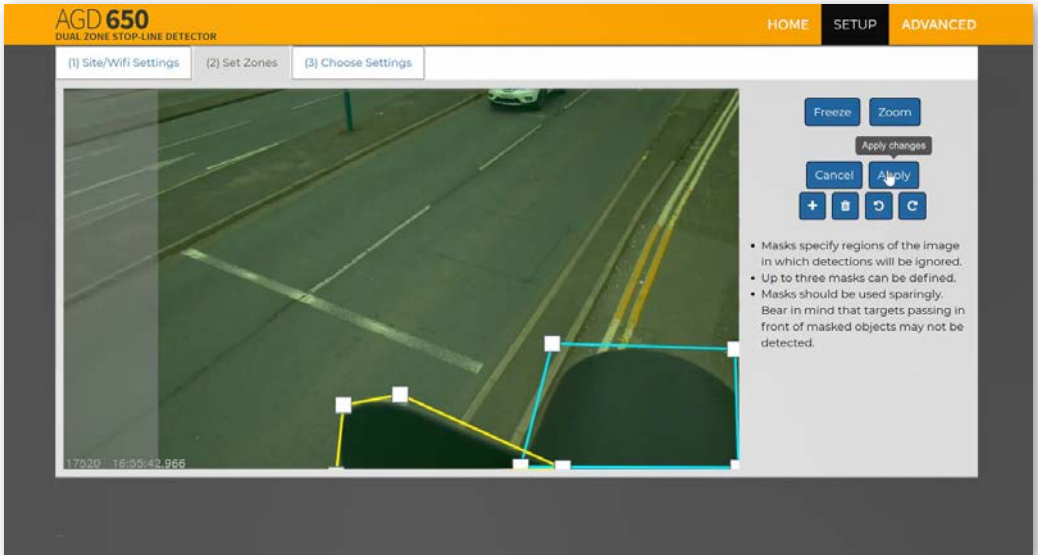

SET-UP DEVICE USING AGD TOUCH-SETUP

Step 2 – Set Zones continued

Detection Zones

Add the detection zones where required (using Zone 1 & Zone 2). The green arrows should follow the direction of traffic and be parallel with the road layout. Lane differentiation can be achieved

by placing zones in the middle of each lane. A gap between each lane is required to stop false detections of adjacent lane traffic.

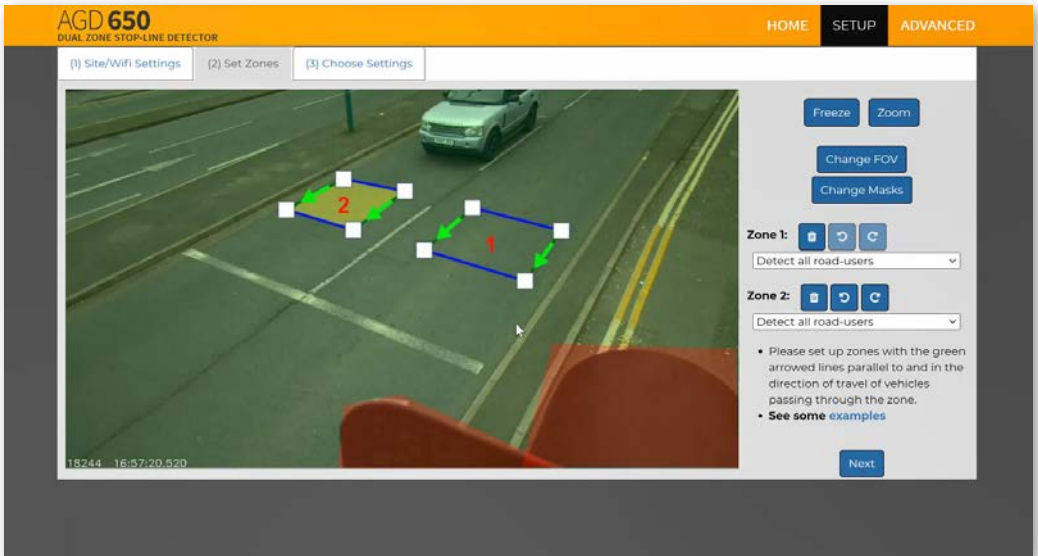

Select the correct option from the drop-down list for your intended application. Each zone operates independently.

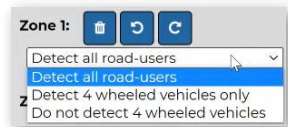

Note: If no zones have been defined, the red LED will be on and both outputs will be in the detect state.

SET-UP DEVICE USING AGD TOUCH-SETUP

Step 3 – CHOOSE SETTINGS

The screenshot shows the 'Choose Settings' page for the AGD650 detector. The page is titled 'AGD 650 DUAL ZONE STOP-LINE DETECTOR' and has navigation tabs for 'HOME', 'SETUP', and 'ADVANCED'. The 'SETUP' tab is active, showing a progress bar with three steps: '(1) Site/WiFi Settings', '(2) Set Zones', and '(3) Choose Settings'. The 'Choose Settings' screen contains several configuration options: 'WiFi off after:' with a dropdown menu set to 'Never' and a 'Turn off wifi NOW' button; 'Detect LED OFF at night:' with a checkbox; 'Hold time (ms)' with two input fields for 'Zone 1' and 'Zone 2', both set to '0'; 'Delay before reporting demand (ms)' with two input fields for 'Zone 1' and 'Zone 2', both set to '0'; 'Timeout (mins):' with an input field set to '0'; 'Audible detection signal:' with a checkbox; 'Enter non-detect fault mode after:' with a dropdown menu set to '72 Hours'; and 'Detection threshold (%)' with an input field set to '30'. A 'Finish' button is located at the bottom right of the form.

WiFi off after – Select how long you would like the WiFi to stay on after you have disconnected. The device will need to be power cycled to have the WiFi network viewable after the selected period.

Input range = 0 – 48h. Default = Never

Detect LED OFF at night – Select to disable red LED at night

Hold time (ms) – The amount of time the detection output is held on after a valid target leaves zone 1 or 2.

Input range = 0 – 120,000ms. Default = 0ms

Delay before reporting demand (ms) – The amount of time the detection output is not reported after a valid target enters zone 1 or 2.

Input range = 0 – 60,000ms. Default = 0ms

Timeout (mins) – The amount of time the detection output is permitted to stay ON.

Once the set timeout figure (mins) is reached the detector will go into a NON DETECT state until that vehicle has moved and another vehicle enters the detection zone

Input range = 0 – 120mins. Default = 0, OFF (never times out)

Enter non-detect fault mode after – If no valid targets are detected in any defined detection zone for this amount of time, the detector will revert to a permanent detect state. This state will persist until a target is detected.

Detection threshold (%) – The threshold value at which the detector will report a valid target. Percentage figures can be seen on the home screen when looking at the live traffic view.

Input range = 0 – 100%.

Default = 30 (recommended)

SET-UP DEVICE USING AGD TOUCH-SETUP

After configuring settings and clicking the Finish button, it is recommended to power cycle or reboot (via the ADVANCED tab) the device, reconnect and confirm that all zones and settings are configured as required.

EXAMPLE IMAGE 1

An example of what you will see once all steps have been completed correctly.

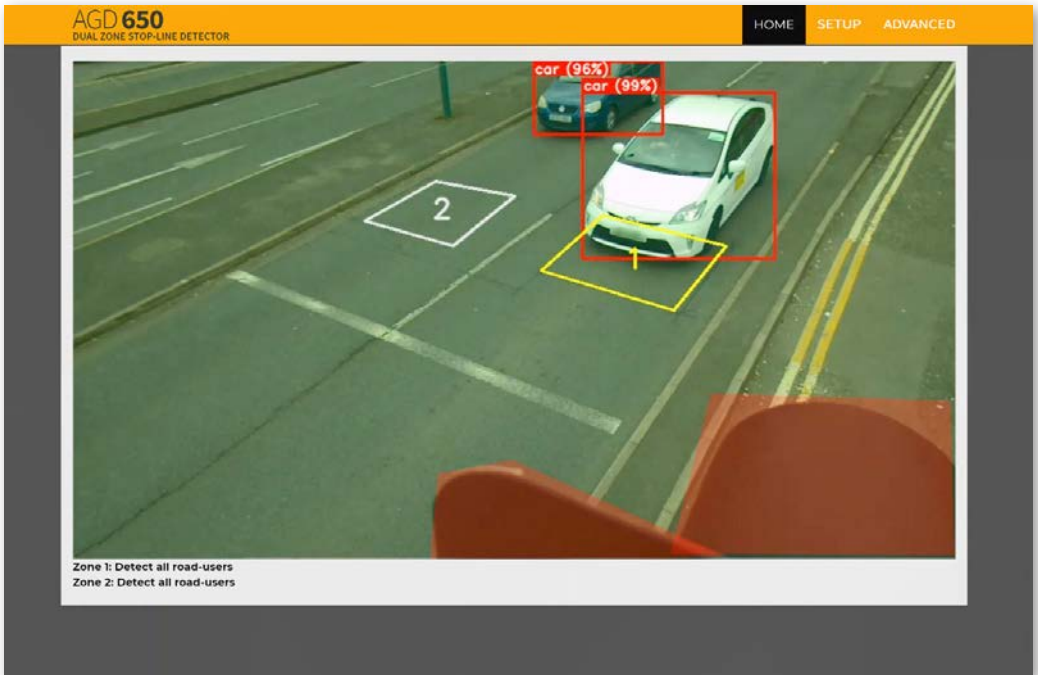

EXAMPLE IMAGE 2

An example of what you will see once all steps have been completed correctly.



ENABLING BUS-ONLY DETECTION

AGD650

AI Multi Modal Detector

INTRODUCTION

To set up a zone for bus-only detection, click the drop-down menu corresponding to the zone on the Set Zones screen. This will open the Detection Classes dialog window. Select the Custom option and then the Buses checkbox.

To ensure the most reliable results for bus-only detection, we recommend adhering to the following guidelines. Please be aware that this is for guidance only and is not able to cover all scenarios or locations available globally. If in doubt, please contact AGD Systems, or your authorised AGD distributor for further details.

AGD650

The AGD650 is a AI Multi Modal detector. After its initial release to market, we are now looking to take advantage of the benefits of the AI platform on which this unit is based by enhancing the features available. Part of this enhancement is enabling classification filtering. This innovative feature represents a significant advancement in the capabilities of the detector, improving its performance and allowing for more precise management of traffic according to conditions.

Classification Filter

The AGD650 is able to identify and classify targets within its operational scope as a stop line detector. The addition of class filtering will allow the end user to discriminate between targets and choose to activate outputs on only the targets they wish to do so. AGD is committed to the performance and continual enhancement of its products. As part of the pre-release data collection and testing, we have identified certain circumstances where classification filtering performance may fall short of what it expected of an AGD product. This guidance is designed to provide information on how to minimise any incorrect class identification that may occur.

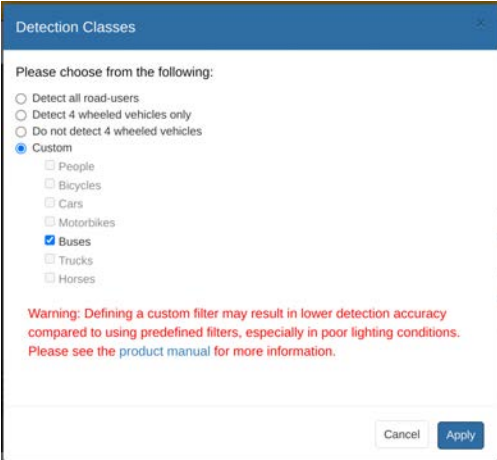

Detection Classes

Please choose from the following:

- Detect all road-users
- Detect 4 wheeled vehicles only
- Do not detect 4 wheeled vehicles
- Custom
 - People
 - Bicycles
 - Cars
 - Motorbikes
 - Buses
 - Trucks
 - Horses

Warning: Defining a custom filter may result in lower detection accuracy compared to using predefined filters, especially in poor lighting conditions. Please see the [product manual](#) for more information.

Cancel Apply

CONSIDERATIONS FOR BEST PERFORMANCE

Ambient Lighting Levels

The minimum recommended light level for the AGD650 is 20 Lux. This should be taken into consideration when choosing an appropriate mounting location. The AGD650 also incorporates an IR lens filter (to assist performance in bright/sunny conditions) so additional IR illumination is not available with this product.

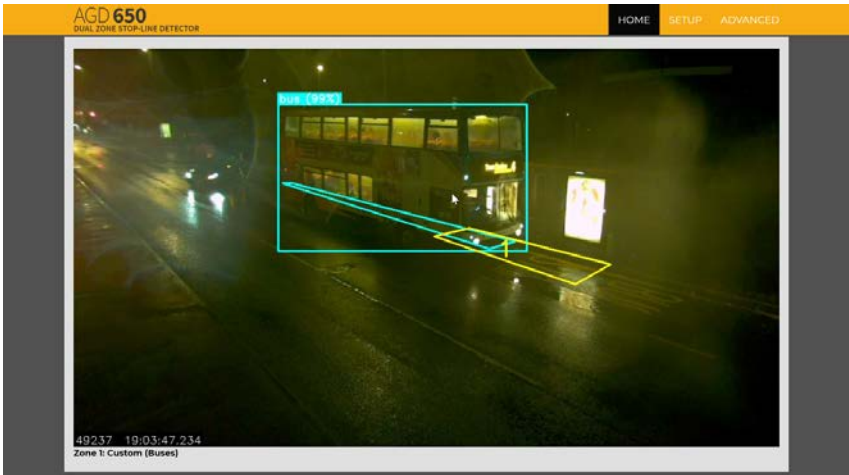
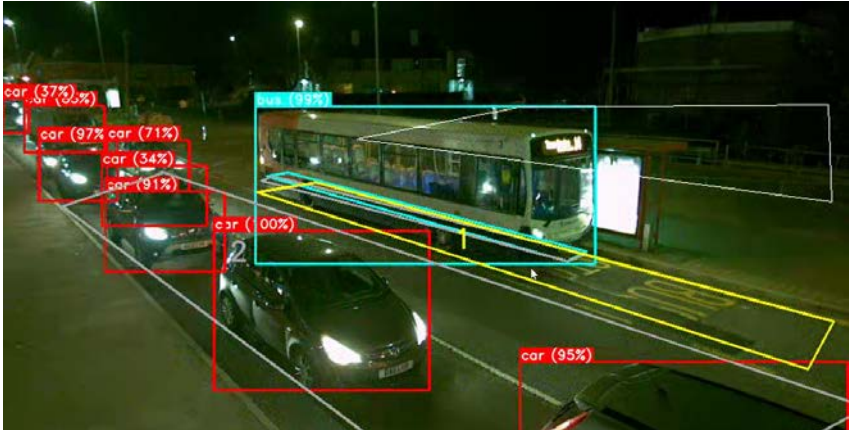

Even in low natural light and poor weather conditions, with the correct ambient lighting, accurate detections can be achieved.

Location of Detector and Detection Area

Correct location and alignment are crucial to the correct operation of the AGD650. Firstly, the mounting location must be chosen carefully. Below is an example of incorrect mounting location.

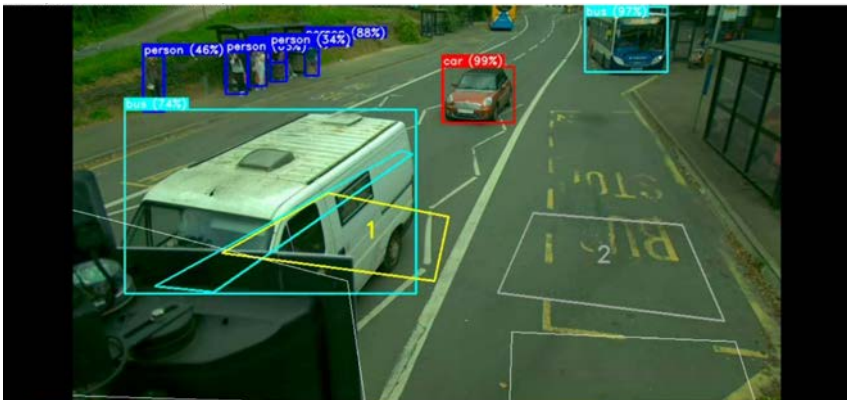
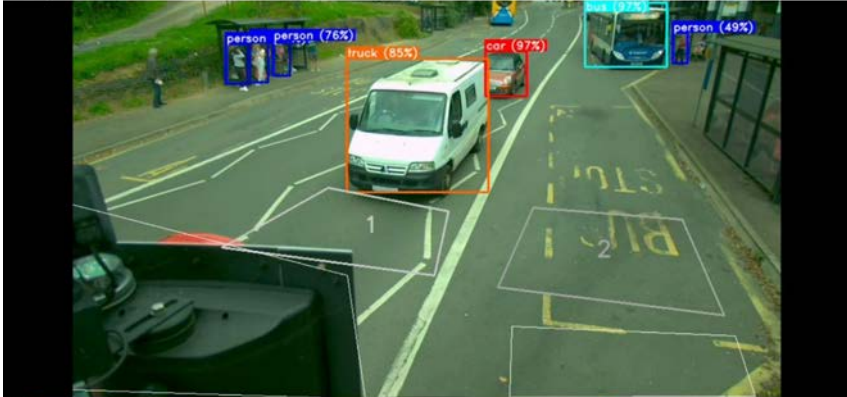

The intrusion of the lamp head into the area immediately after the detection zone 'blocks' the detector's view of targets, causing issues with certain vehicles being incorrectly classified when they are partially obscured.

ENABLING BUS-ONLY DETECTION

AGD650

AI Multi Modal Detector

The below picture shows changes required.

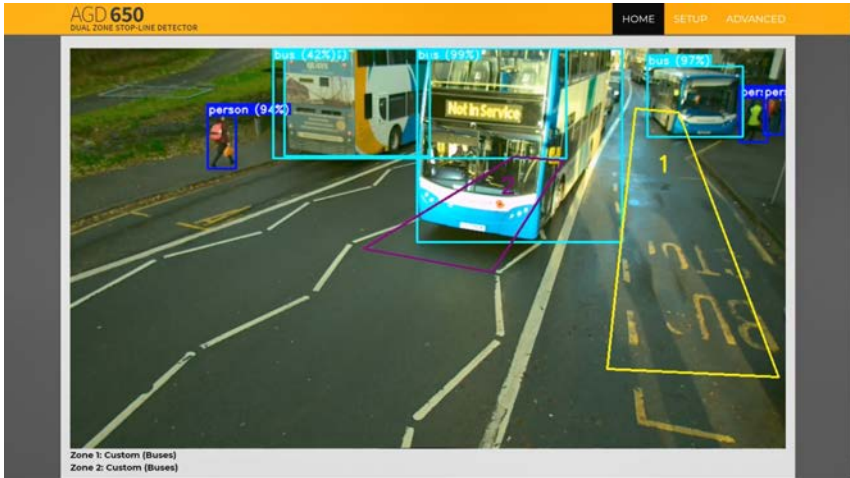
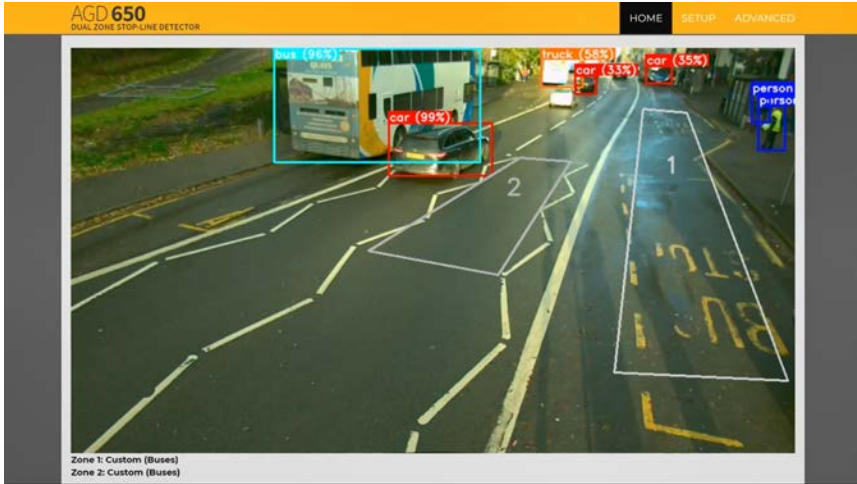

- a) Detector mounting location adjusted to remove lamp head obstruction
- b) Detection zone moved away from stop line to give a clear area between the detection zone and the edge of the field of view of the detector

As a rule of thumb, the ideal detection area will be between 10m and 20m from the detector.

ENABLING BUS-ONLY DETECTION

AGD650

AI Multi Modal Detector

Visibility of Whole Target

Visibility of the entire target within the detector field of view is desirable. If the entire target is not visible, this can lead to low confidence levels, or incorrect classification of targets.

Ideally a full vehicle length will be visible before and after each detection zone.

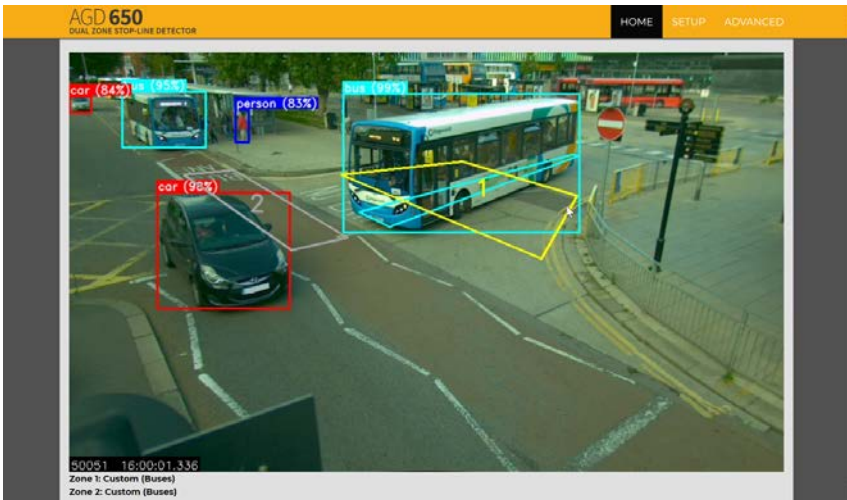

Physical Installation

If the unit is not operating correctly, please check that the unit has been:

- 1) Mounted within the recommended height of 3–6 metres?
- 2) Angled according to the installation guide to provide good coverage of the detection area?
- 3) Installed without any obstructions in the viewable area such as the traffic signal head?

Electrical Installation

If the unit is not operating correctly, please check the following:

- 1) Is power present at the unit?
- 2) Is the red LED illuminated when power is first applied to the unit?
- 3) Is there sufficient current to run the unit – identified by the red LED failing to flash or flashing only once during power-up and the web page not starting correctly? Refer to technical specification table.

Connecting / Commissioning

If the unit is not operating in the prescribed manner, please check the following:

- 1) Is the LED on the underside of the unit you wish to connect to illuminated blue to show that the WiFi network is successfully connected?
- 2) Has the correct IP Address been entered into the browser address bar?
- 3) Have you followed the AGD Touch-setup stages correctly and verified correct operation?

If trouble with operation persists please contact AGD Technical Support.

AGD Technical Support

Email: technical@agd-systems.com

Tel: +44 (0) 1452 557404

TECHNICAL SPECIFICATIONS

AGD650

AI Multi Modal Detector

PRODUCT DIMENSIONS

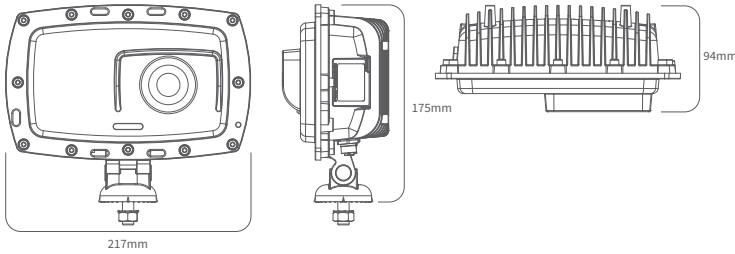

SPECIFICATIONS

Description	AI Multi Modal Detector	
Technology	AGD Optical Vision with AI	
Detection Zone	Dual Virtual Loops	
Mounting Height	3-6m Nominal	
Power Supply	24V ac/dc, 42V ac	
Typical power at 20°C	2024 onwards (>= MI-220-8): 10.5W @ 24V ac; pre-2024 (<= MI-220-7): 12W @ 24V ac.	
WiFi Frequency/Power	2412-2472 MHz / Highest EIRP power in the range (dBm): 19.7	
LED Indication	LEDs for detect and WiFi connection	
Frames per second	6.7	
Housing Material	Black Polycarbonate / Aluminium	
Range	20m at full FOV / 30m at reduced FOV	
Ingress Protection	IP66	
Operating Temp	-34°C to +74°C	
Configuration	WiFi AGD Touch-Setup	
Lux Level	Operates down to 20 Lux	
Dimensions	W 217mm x D 94mm x H 175mm	
Weight	1200g	
Complies with	EMC:	EN50293:2012 EN301 489-17 V3.2.4 EN301 489-1 V2.2.3
	Health & Safety:	EN IEC 62368-1:2020+A11:2020 EN 50556:2011 EN 62479:2010
	Spectrum:	EN 300 328 V2.2.2 FCC CFR47 Part 15.247, RSS-247
	ROHS:	EN IEC 63000:2018
	Other:	TOPAS 2505B Appendix E
Patent No.	Patent Pending - GB2619098	

Owing to the Company's policy of continuous improvement, AGD Systems Limited reserves the right to change their specification or design without notice.



END OF LIFE - DISPOSAL INSTRUCTIONS (EOL)

AGD650

AI Multi Modal Detector

AGD650 AI MULTI MODAL DETECTOR

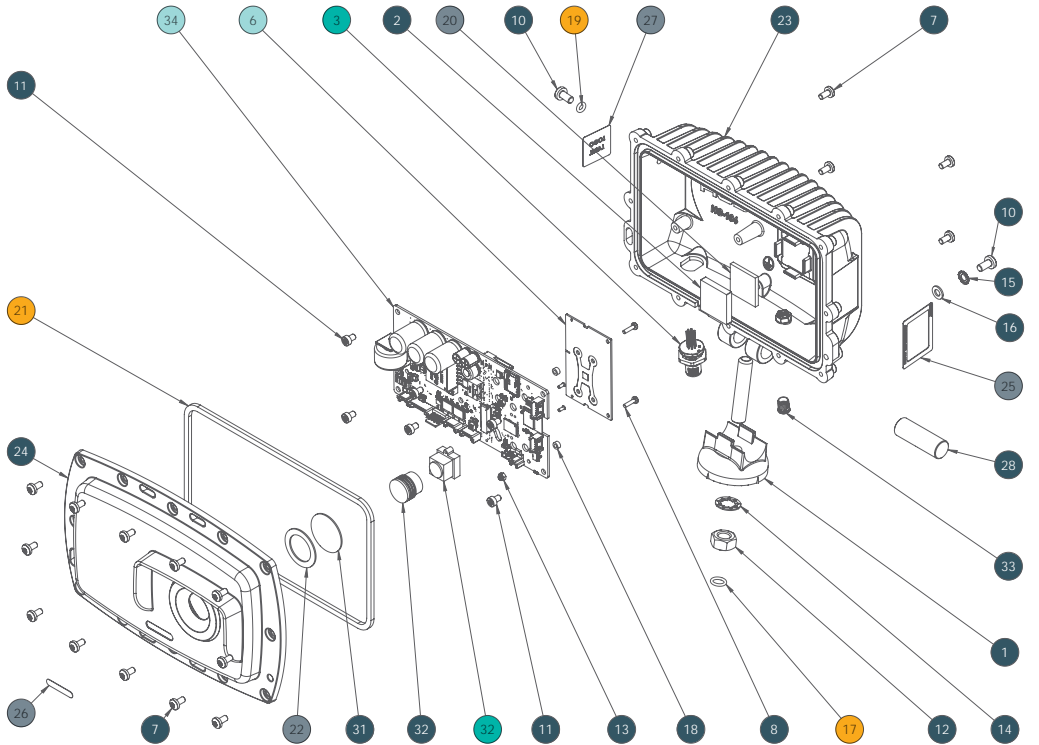

Item	Qty	Material
1	1	Polycarbonate
2	1	Copper
3	1	Mixed Metals, PVC
4	1	Mixed Metals, PVC & Nylon
5	1	Mixed Metals, PVC & Nylon
6	1	PCB Assembly
7	16	Stainless Steel
8	2	Stainless Steel
9	2	Stainless Steel
10	2	Stainless Steel

Item	Qty	Material
11	6	Stainless Steel
12	1	Stainless Steel
13	2	Stainless Steel & Nylon
14	1	Stainless Steel
15	1	Stainless Steel
16	1	Stainless Steel
17	1	Nitrile
18	2	Nylon
19	1	Nitrile
20	1	Aluminium Oxide
21	1	Nitrile
22	1	HSAP

Item	Qty	Material
23	1	Aluminium
24	1	Polycarbonate
25	1	Polyester
26	1	Polyester
27	1	Polyester
28	1	Aluminium
29	1	Stainless Steel
30	1	Polycarbonate
31	1	Glass
32	1	ABS & Glass
33	1	Polycarbonate & Steel
34	1	PCB Assembly

- Reuse / Recycle
- Separate & Recycle
- Downcycle
- Hazardous Recovery
- Non-Recyclable

SAFETY PRECAUTIONS

All work must be performed in accordance with company working practices, in-line with adequate risk assessments. Only skilled and instructed persons should carry out work with the product.

Experience and safety procedures in the following areas may be relevant:

- **Working with mains power**
- **Working with modern electronic/electrical equipment**
- **Working at height**
- **Working at the roadside or highways**

1. This product is compliant to the Restriction of Hazardous Substances (RoHS – European Union directive 2011/65/EU, UK Statutory Instrument 2012/3032)
2. The product must be correctly connected to the specified power supply. All connections must be made whilst the power supply is off or suitably isolated. Safety must take always take precedence and power must only be applied when deemed safe to do so.
3. No user-maintainable parts are contained within the product. Removing or opening the outer casing is deemed dangerous and will void all warranties.
4. Under no circumstances should a product suspected of damage be powered on. Internal damage may be suggested by unusual behaviour, an unusual odour or damage to the outer casing. Please contact AGD for further advice.
5. This Product is Compliant with the European Radio Equipment Directive 2014/53/EU & UK Radio Equipment Regulations 2017 (SI2017/1206) There is no restrictions of use within any EU Member state for this product. This product is Receiver Category 2.
6. Indicates compliance with all applicable Australian ACMA technical standards and associated record keeping (including testing) arrangements.

/contd

IMPORTANT

AGD650

AI Multi Modal Detector

SAFETY PRECAUTIONS

7. This device complies with part 15 of the FCC Rules and contains licence-exempt transmitter(s)/ receiver(s) that comply with Innovation, Science and Economic Development Canada's licence-exempt RSS(s).
- Operation is subject to the following two conditions:
 - (1) This device may not cause harmful interference, and
 - (2) This device must accept any interference received, including interference that may cause undesired operation

Le présent appareil est conforme aux CNR d'ISDE Canada applicables aux appareils radio exempts de licence.

L'exploitation est autorisée aux deux conditions suivantes : (1) l'appareil ne doit pas produire de brouillage, et (2) l'appareil doit accepter tout brouillage radioélectrique subi, même si le brouillage est susceptible d'en compromettre le fonctionnement.

- This equipment complies with FCC radiation exposure limits set forth for an uncontrolled environment. End users must follow the specific operating instructions for satisfying RF exposure compliance such that the module should not be installed in equipment intended to be used within 20cm of the body.
- The transmitter must not be co-located or operating in conjunction with any other antenna or transmitter.
- Changes or modifications not expressly approved by AGD Systems Ltd could void the user's authority to operate the equipment.



DISCLAIMER

While we (AGD Systems) endeavour to keep the information in this manual correct at the time of download or print, we make no representations or warranties of any kind, express or implied, about the completeness, accuracy, reliability, suitability or availability with respect to the information, products, services, or related graphics contained herein for any purpose.

Any reliance you place on such information is therefore strictly at your own risk. In no event will we be liable for any loss or damage including without limitation, indirect or consequential loss or damage, or any loss or damage whatsoever arising from loss of data or profits arising out of, or in connection with, the use of this manual.

Warranty

All AGD products are covered by a 12 month return to factory warranty. Products falling outside this period may be returned to AGD Systems for: evaluation, repair, update or re-calibration, any of which may be chargeable.

Revision
Issue 6 May 2024



AGD[®] | SAFER
GREENER
MORE EFFICIENT

AGD Systems Limited

White Lion House, Gloucester Road,
Cheltenham, GL51 0TF, UK

Tel: +44 (0) 1452 854212

Email: info@agd-systems.com

Web: agd-systems.com